



Quality for the world

CS 486 Ultra

AIR-OPERATED ELECTRONIC UNDERPINNER



Technical and User Manual

Version 4 - 12/2003

GETTING FAMILIAR WITH YOUR CS 486 ULTRA

Fig 1

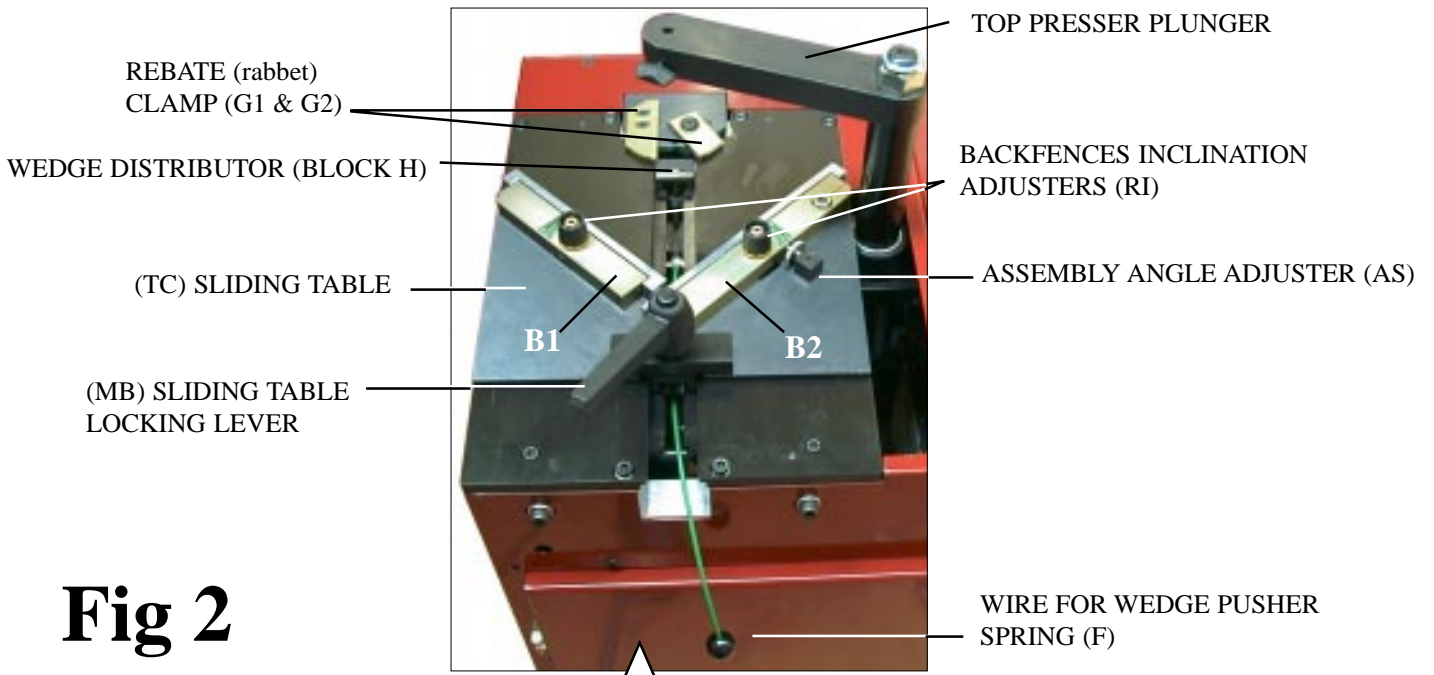
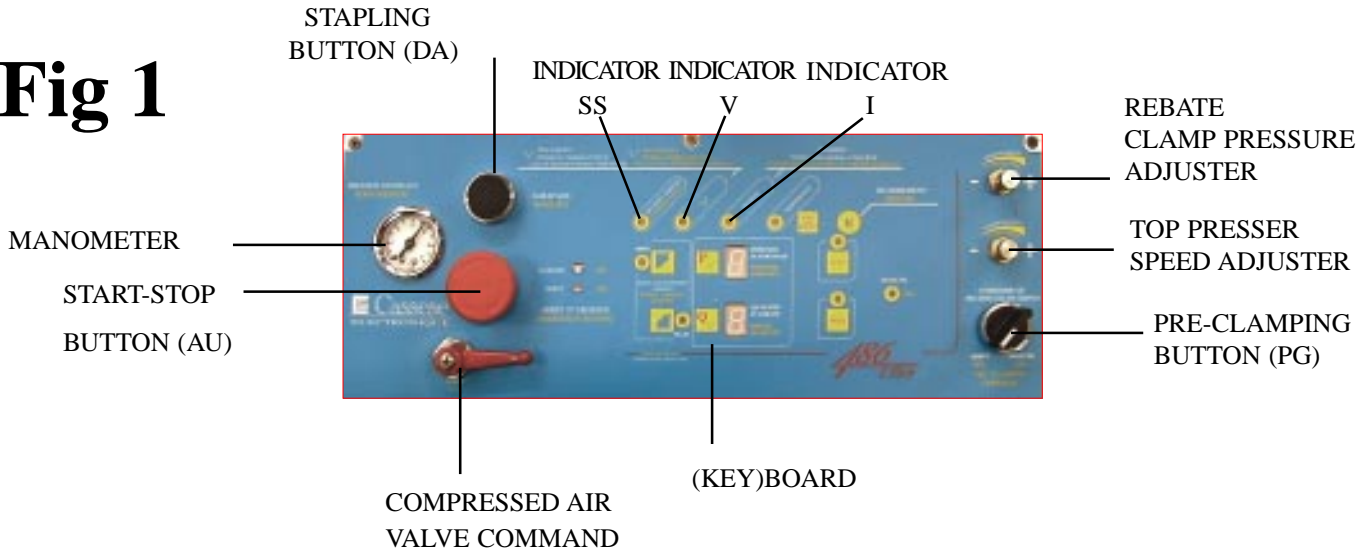

Fig 2

▲
REFERENCE WORK POSITION for explanations

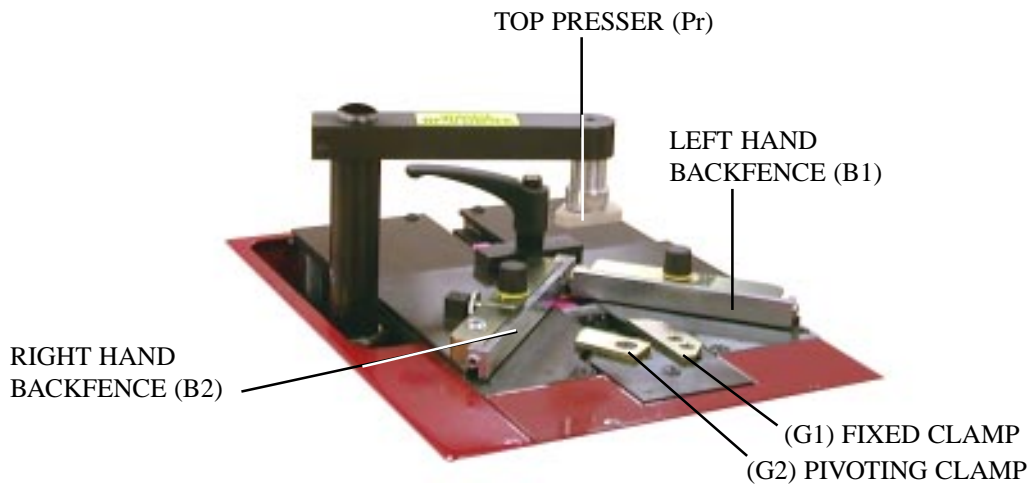

Fig 3

CS 486 ULTRA AIR LINE FITTINGS

Advised way of fitting :



Z 675

USA

STANDARD

Male Connector
on Machine



Z 675



quick release (Q/R)
female air connector

Z 749



Q/R US male
connector

Z 701

Standard hose
connector

Z 556

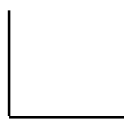

AIR SOURCE (compressor)

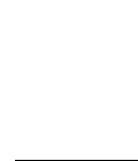

CONNECTING TO COMPRESSED AIR



Open the access trap of the machine with the trapdoor key supplied. See above for the air fittings supplied with machine accessories. **Before** connecting the compressed air arrival hose to these fittings, **screw into** the quick release female connector **QR** EITHER the standard hose connector OR the US male connector. Then, connect it to an air source of 7 bars (100 psi).

CS 486 Ultra v3

CONTENTS

	<u>Pages</u>
<u>IMPORTANT</u>	
- GETTING FAMILIAR WITH YOUR CS 486 Ultra	A
- CONNECTING TO COMPRESSED AIR SUPPLY	B
<u>INTRODUCTION</u>	
- ACCESSORIES	1
- SPECIFICATIONS	
- OPTIONS	
- GUARANTEE	
<u>INSTALLATION</u>	
- PREPARATION	2
- CONNECTING TO ELECTRICITY	
- CONNECTION TO POWER SUPPLY	
<u>PUTTING INTO OPERATION</u>	2
<u>ADJUSTMENTS</u>	
- CHOICE OF A TOP PRESSER	3
- USE OF THE SET OF SPACER BARS	3
- ADJUSTING THE SLIDING TABLE	4
- ADJUSTING THE INCLINATION OF THE FENCES	4
- ADJUSTING THE ASSEMBLY ANGLE	5
<u>USE</u>	
- MEANS OF ASSEMBLY	6
- LOADING & CHANGING THE WEDGE CARTRIDGE	6
- SELECTION OF STAPLING POSITIONS	6
- SETTING & RECORDING AN ASSEMBLY PROCESS (EXAMPLE WITH 5 WEDGE POSITIONS)	7-8
- ASSEMBLING FRAMES	9
<u>MAINTENANCE</u>	
- ERROR MESSAGES E-0 / E-1	10
- CLEARING A WEDGE HALF ENGAGED IN WEDGE DISTRIBUTOR	10
- IN CASE OF HAMMER & WEDGE JAMMING + REPLACING HAMMER	11
- ERROR MESSAGES E2 - E3 - E4 - E5 - E6 - E7 - E8	12

INTRODUCTION

You have just bought a CS 486 Ultra numeric frame joining machine, so we congratulate on your sensible choice and thank you for your trust in Cassese products.

The CS 486 Ultra benefits from the experience of the joining machines that brought Cassese a certain reputation. It makes it possible to join wooden mouldings of all profiles (patent n° 7522814).

The CS 486 Ultra is designed to allow the operator to move all around the machine.

The joining operation is carried out by using metal wedges especially designed to perform a tight join. These wedges come in throw-away plastic cartridges, without glue, individually lubricated and rust-protected for the toughest challenges.

**IMPORTANT : Do not use any other wedge cartridges but genuine Cassese cartridges.
(registered mark CS).**

ACCESSORIES SUPPLIED WITH THE MACHINE

The CS 486 comes with a cardboard accessory box that contains:

- 1 Key for machine door
- 1 triangle support with 1 black rubber triangle (hard) +1 white triangle (soft)
- 1 extra long triangle support (for fast work with very small profiles)
- 1 round rubber support with - according to mouldings shape and height:
 - 2 green rubber ends for hardwood types (1 short and 1 long)
 - 2 yellow rubber ends for soft wood types (1 short and 1 long)
- Spacer bars for small mouldings / 3 allen keys for hexagonal nuts (# 2.5 – 3 –5mm)
- 1 Wedge pusher tool / 1 spare hammer (wedge driver blade) / 1 tube of grease
- 1 Air exhaust Silencer (muffler) / 1 quick release female air connector for the male one that is on machine / 1 quick release US male connector / 1 hose connector /
- 2 wires to connect machine to mains supply (one with standard + one with US plug).

TECHNICAL SPECIFICATIONS OF CS 486 ULTRA

- Moulding width : Minimum 3 mm ($\frac{1}{8}$ ") - maximum width : 130 mm ($5\frac{1}{4}$ ")
- Moulding height : Minimum 5 mm ($\frac{3}{16}$ ") – maximum 90 mm ($3\frac{3}{4}$ ")
- Minimum dimensions of a frame : 85 mm x 85 mm visibly ($3\frac{1}{2}$ " x $3\frac{1}{2}$ ")
- Wedge sizes in cartridges of 275 pieces : 5, 7, 10, 12 and 15 mm. On special order size #4 and #3 ($\frac{1}{8}$ ") are also available for assembly of slips (filets).
- Two wedge types : for soft and for hardwoods. **Don't use Hardwood wedges on softwoods.**
- Machine weight : 100 kg (222 lbs)
- Dimensions : Width 48 cm (19") x Depth 44 cm ($17\frac{1}{2}$ ") (without optional rotating extension table) x Height 114 cm (45")
- Power supply : Electric : 220 V - 110 V single phased, Consumption 200 W.
Pneumatic : compressed air 7 bar (100 psi). Average consumption: 5 liters / cycle.
- Air preparation : pressure reducing valve + manometer, connecting pipe, inside diameter 8 mm.

OPTIONS

- Independent rotating table, diameter 1300 mm ($50\frac{1}{4}$ ") to make the handling of large frames easier (frame dimensions not exceeding table diameter). Cassese Item # Z.3074.
- Set of furniture clamps to join mouldings without rebate and/or small frames. Item # Z.2763.
- 2 other extra long round rubber supports for faster work on small profiles : +15 mm ($+5/8$ ") longer support : Item # Z.7948 // +30 mm ($+1\frac{1}{4}$ ") longer support : item # Z.7949
- Angle inserts for 6-sided frames (Item Z.3204), for 8-sided (Z.3203) or other forms on request.
- Bar code scanner system .

GUARANTEE

One year guarantee for parts and labour against manufacturing defects. Wear parts and those damaged as a result of non appliance with the instructions of the present manual are excluded from the guarantee.

INSTALLATION

(Connecting to compressed air: see page B)

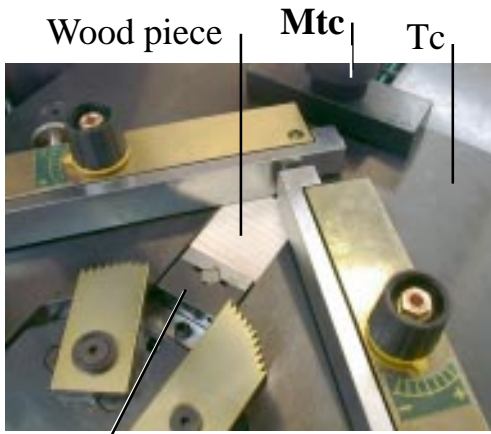

Wedge distributor

FITTING THE SILENCER (MUFFLER)

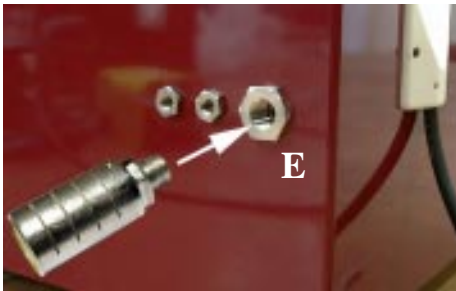

Screw the silencer on machine's frame into nut E. Put some grease on the (threaded) screw part of the silencer ; a full tube of grease is delivered in the accessory box of the machine.

To change machine to 110 V,

with a flat screwdriver, remove from underneath the selector S, and turn it upside down. Push it back in. The voltage needed by machine is marked in **left, upper corner of selector S**.

CONNECTING TO ELECTRICITY

Your machine comes with the voltage selector (S) in position 220-240 V. If your local tension is 110 V, just follow the instructions below and connect machine to 220 or 110 V single phased grounded power socket, either with the cable supplied with standard plug or with the one that has a US plug at its end.

Voltage needed

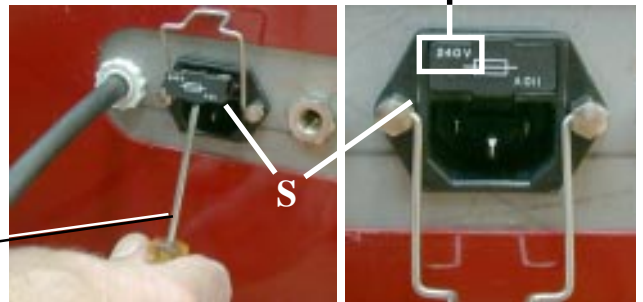

Turn the red Start/Stop button (AU) (Fig.1) so that it comes up to START (ON) position. Press on R-key (Fig.2) (RESUME) on the keyboard to confirm the start :

- all indicator lights come on and off
- machine introduces the version of its program : e.g. 1-2
- wedge position P and quantity Q indicators start to blink

Pressing any key or the foot pedal, the 486 Ultra initialise itself and is ready to be set for wedge position P # 1. Now all keyboard lights are fixed.

PUTTING INTO OPERATION

Turn on the compressed air valve. The pressure shown on manometer should be between 6 to 7 bars (90 to 100 p.s.i.) If your compressor is sending out a higher pressure but the manometer is showing less, increase the pressure at machine's regulator -where the air arrival is connected.

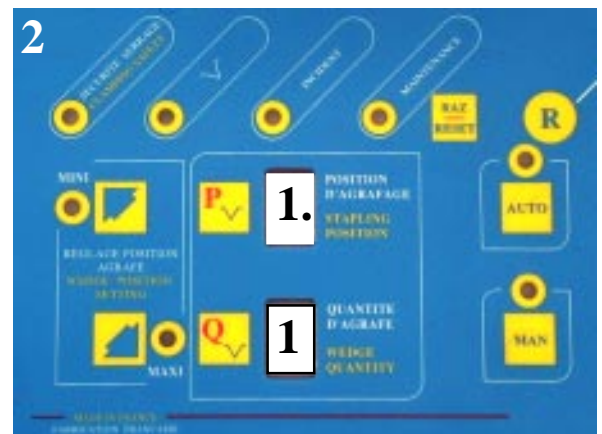

ADJUSTMENTS

SELECTION OF A TOP PRESSER END

Make sure that the distance between the moulding's top and the presser's bottom is not more than 50 mm (2").

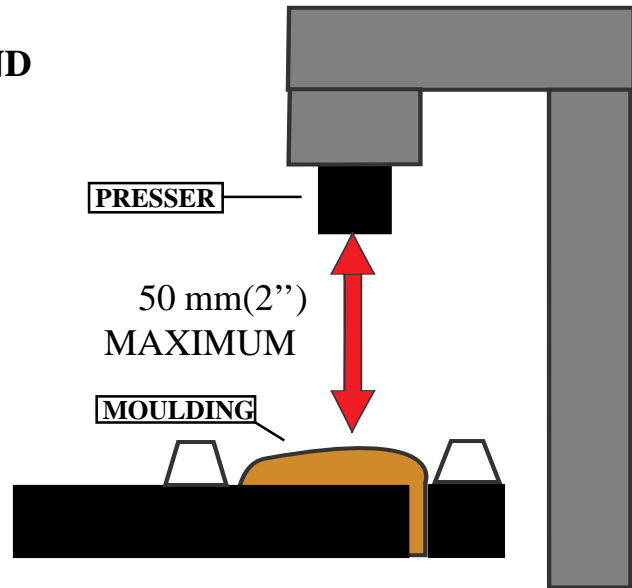

If the distance is bigger, use a longer top presser end. For very tall mouldings the round rubber tips can be also inserted into the top presser bracket without their support to gain capacity in height.

BLACK TRIANGLE PRESSER	FOR HARDWOODS	mounted on support with a 2.5 mm Allen key
WHITE TRIANGLE PRESSER	FOR SOFTWOODS	
GREEN RUBBER TIPS	FOR HARDWOODS	1 long and 1 short
YELLOW RUBBER TIPS	FOR SOFTWOODS	1 long and 1 short

Triangle top pressers are good for flat mouldings or for mouldings presenting a flat or horizontal area to come down on. The round rubber ends are good for complicated forms (uphill, downhill or reverse mouldings).

USING THE SET OF SPACER BARS

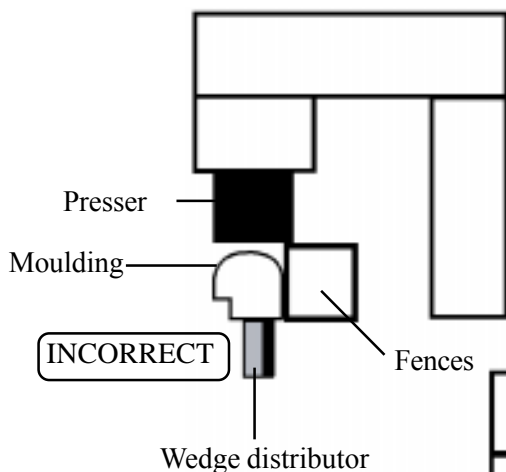

In case you have to join small mouldings with a smaller height than the fences, you must put the spacer bars between the mouldings and the fences to create a distance.

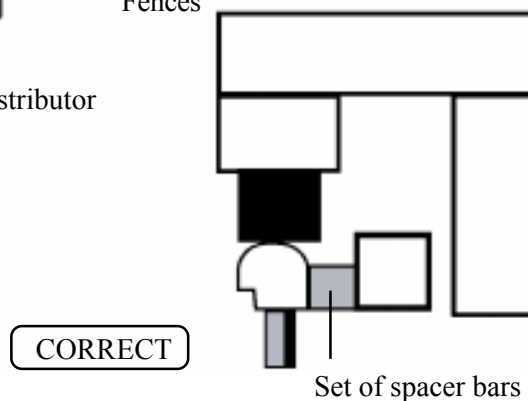

ADJUSTING THE SLIDING TABLE TO THE MOULDING

- 1) Turn to ON the pre-clamp command button PG (Fig 1 page A) to make advance slightly the rebate (rabbet) clamp of the machine **G1 & G2** (Fig 1).
- 2) Make sure that the knobs of backfences inclination adjusters RI (Fig 2, page A) are at 0 (zero).
- 3) Standing behind the machine (as seen on Fig.2, page A), put a moulding chop against left hand fence **B1**.
- 4) Move sliding table TC (fig2 pA) forward as far as the moulding comes into contact with the clamp G1 (fig1, pageA).
- 5) Tighten the sliding table blocking handle MB (fig2,pA).
- 6) Now you can turn the pre-clamp button PG to OFF position again.

ADJUSTMENT OF THE INCLINATION OF THE FENCES

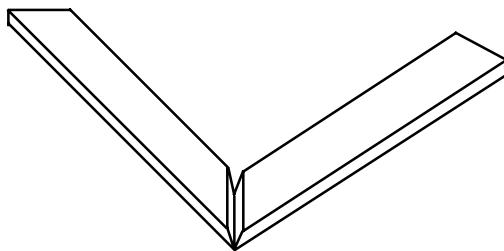
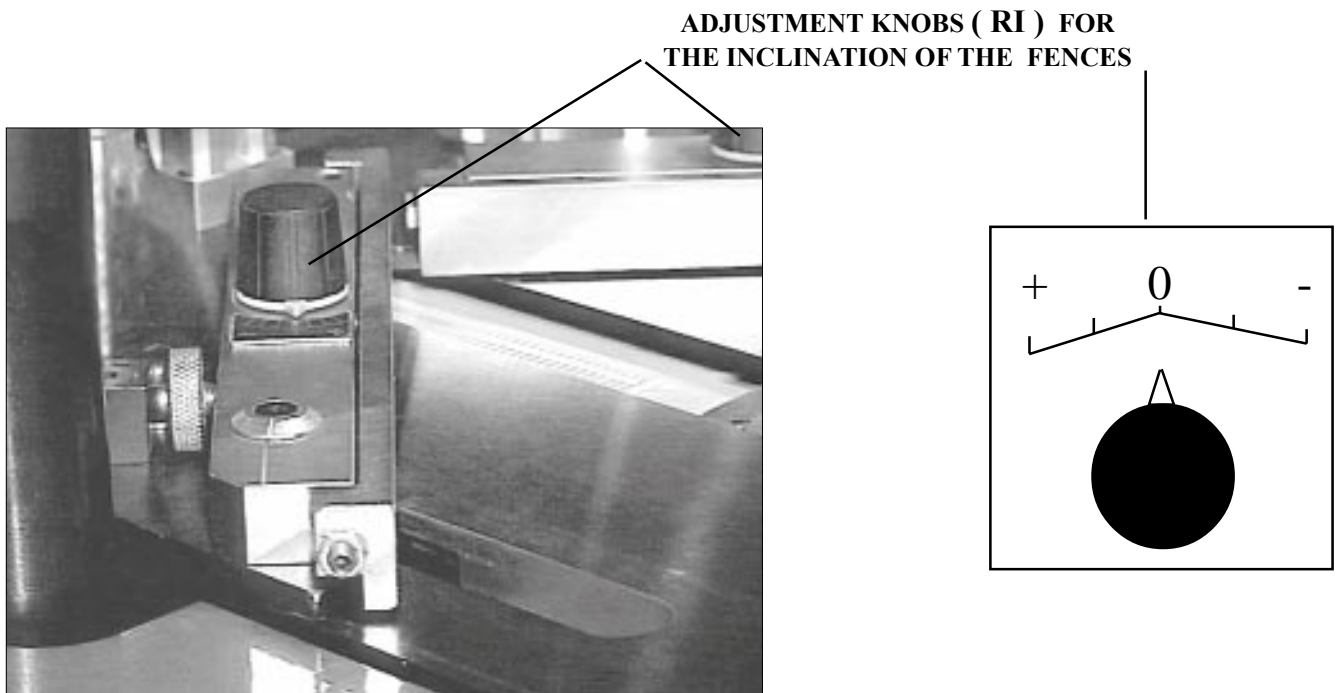

If the corner has an opening **on top**, turn the two adjustment buttons (RI) an identical value to the MINUS (-) (see above picture) until the opening disappears when mouldings are clamped.

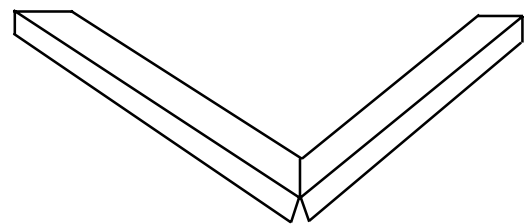

If the corner has an opening **underneath**, turn the same two adjustment buttons (**RI**) an identical value to the PLUS (+) until the opening disappears when mouldings are clamped.

ADJUSTMENT OF THE ASSEMBLY ANGLE

If several cutting machines are being used in your production or if you receive your mouldings already cut by your suppliers (chop service), the angles of the mouldings will be slightly different from one cutting machine to the other. The wider the moulding the more visible will be this angle difference. This is why the joining angle of your CS 486 Ultra can be adapted to find precisely the cutting angle of the cutting machine.

If the corner is open towards outside, (standing behind the machine) screw in the adjustment screw AS (see picture below) to correct the fault and check the quality of the angle by clamping the corner again.

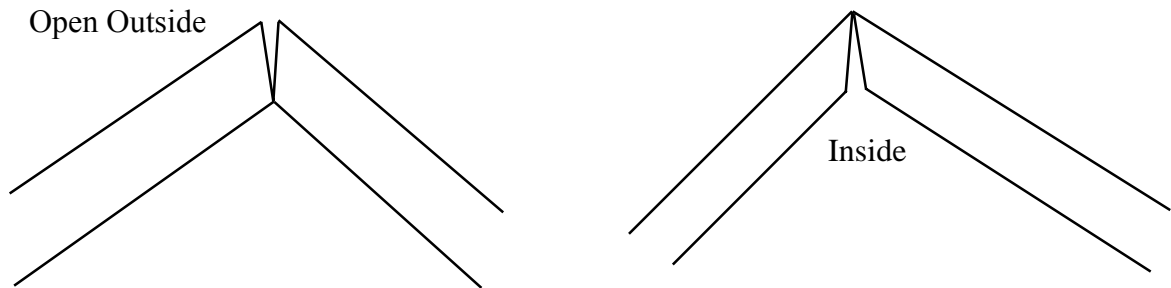

If the corner is open towards inside, unscrew the same angle adjuster AS to correct the fault and check the quality of the corner by clamping the mouldings again.

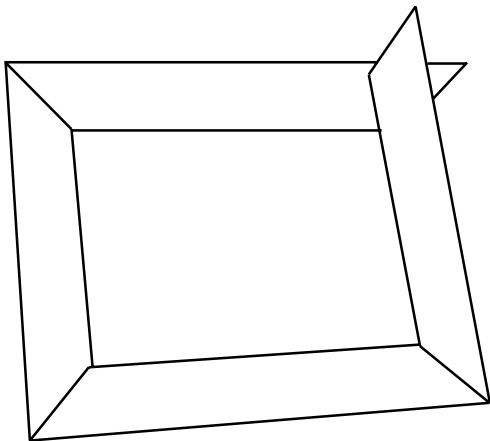

In the event of such a result, check your cutting angle that is actually bad because under 45° .

Have the angle of your cutting machine corrected, as it is impossible to make a rectangle frame with angles smaller than 90° .

**(AS) SETTING SCREW FOR
THE ASSEMBLY ANGLE**



USE

MEANS OF ASSEMBLY



The joining is performed by using metal wedges, a Cassese invention, designed to ensure very tight corners. Five standard sizes are available : 5, 7, 10, 12 and 15 mm. On special request #3 & 4 are available for slips (filets). They all come in throw-away cartridges that are colour-coded per size for easy identification.

Cartridge wedges exist in two versions : NORMAL for soft and normal timbers and HW for very hard timbers. These hardwood wedges are to be used only on hardwoods. Your CS 486 Ultra is designed to use all sizes of Cassese cartridges without having to change any parts on the machine or having to adjust anything. For the long term performance and reliability of your CS 486 Ultra, only use genuine CASSESE wedge cartridges. Beware of bad quality copies that would cause technical problems and would age your machine prematurely.

LOADING AND CHANGING THE WEDGE CARTRIDGE ON MACHINE

Pull the wire with ball of the wedge pusher spring F (fig.2, page A) fully out.

If there is a cartridge on machine, holding the wire pulled out, remove it by simply sliding out the cartridge.

Holding the wire pulled out, put a new cartridge on machine and pay attention that it is fully inserted in the wedge distributor's window.

Release gently the wire with ball of the wedge pusher spring F.

SELECTION OF STAPLING POSITIONS

The CS 486 Ultra is designed to join mouldings in 1 to 5 places (positions) with 1 to 5 wedges in any of those places. In the case of several wedges in the same position, they will penetrate the wood pushing the previous wedge(s) deeper inside. The selection of the size of wedge to be used and the number of positions depends on the width and thickness of the moulding to be assembled.

A MINIMUM of 2 mm (approx. 1/8") above the wedges shall be respected. The harder the wood timber, the more should be this clearance to prevent the moulding from cracking.

***Advice** : To get the best and tightest corners possible, make sure that wedges in each position penetrate and pull together at least 2/3 of the height in this area.*

Example: As a general rule, the joining must be carried out as close as possible to the thickest (highest) parts of the mouldings.

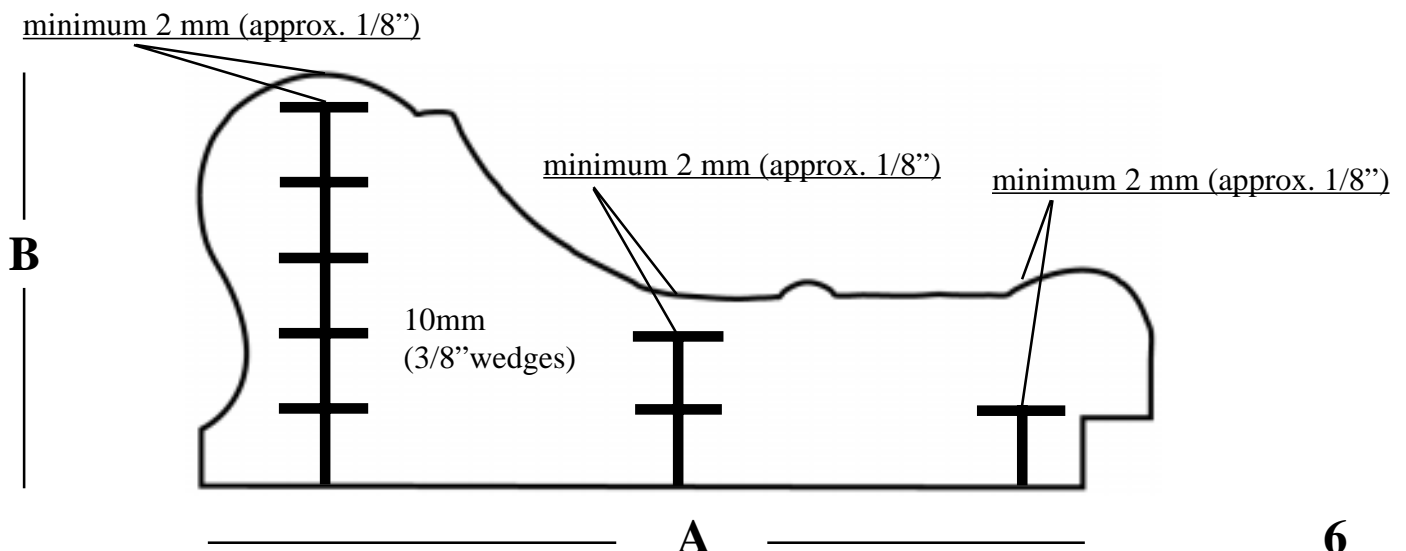

SETTING & RECORDING AN ASSEMBLY PROCESS

EXAMPLE WITH MULTIPLE (up to 5) STAPLING POSITIONS

1) PREPARATION

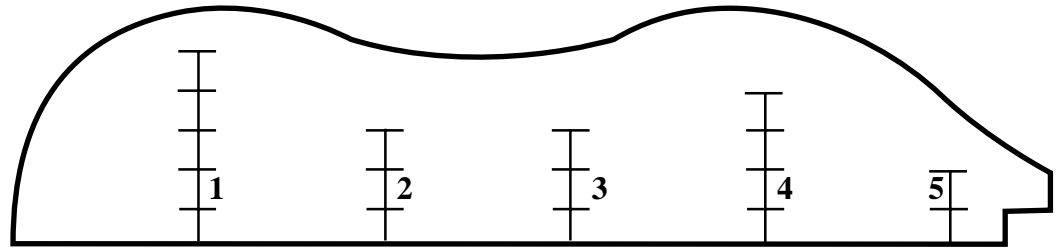

Depending on the width of the mouldings, your CS 486 Ultra can join corners 1 to 5 stapling positions (=areas where the wedges will be inserted). It allows the operator to set up and memorise the stapling positions just by physically bringing the wedge distributor (Block H) to those areas. To do so :

1. Standing in the advised work position (Fig.2, page A) behind the machine, nearer to the keyboard, take the left hand moulding chop on which for the first trials you may mark with a pencil at the bottom of the mitred surface the positions where you want to insert wedges.
 2. Put now this left moulding chop in front of the left back fence B1 (on Fig 2, page A) so that its mitred end is in contact with the right back fence B2.
 3. Turn ON the pre-clamping **button PG** (Fig 1, page A) and press **RESET key** to clear all wedge positions **P** and quantities **Q**.
 4. Now, push the sliding table **TC** forward with the moulding in front of it, until the moulding reaches the rebate (rabbet) clamp (**G 1**). And tighten the position of the table with handle **MB**.
- Pressing **RESET key** when the **pre-clamp button PG** is **ON** clears the last (whole) assembly process from the memory of the machine,
 - Pressing **RESET key** **and** the **wedge position key P** at the same time when the **pre-clamp button PG** is **OFF** clears from record this memorised position,
 - Pressing **RESET key** **and** the **wedge quantity key Q** at the same time when the **pre-clamp button PG** is **OFF** clears the quantity and changes to 0.

Notice : When a wedge position is “empty”, i.e. either not recorded yet or cleared from memory- a dot appears next to the number of the position.

⌘ If the machine has been moved to reach its maximum or minimum capacity to outside or inside of frame, the **MINI** or **MAXI** keys will light up and the move of the mechanism is stopped.

⌘ While setting a wedge position using key , if the machine’s wedge distributor is stopped harshly by the sliding table (TC), because the machine reached the outside limit of the moulding, the stepping motor –counting and recording the position- may skid. In this case, move the machine back using key and turn **Pre-clamp button PG** ON and OFF; this will enable the motor to initialise itself to record correctly the next wedge position.

a) First Stapling Position P1 (outside of the frame)

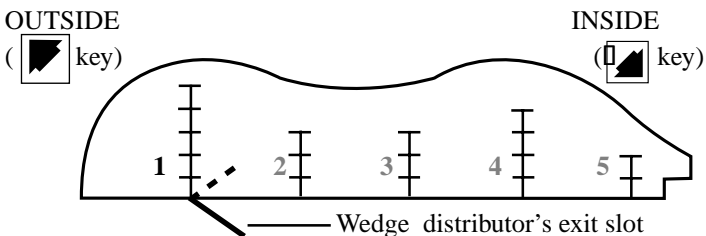

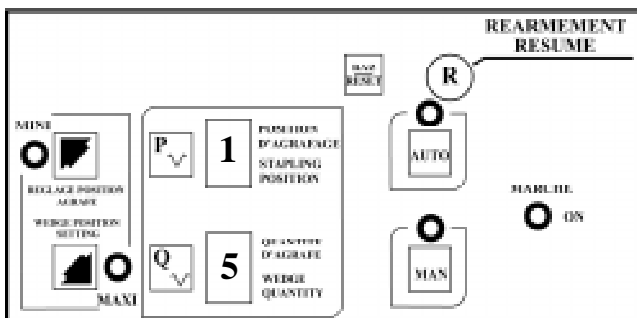

Although the CS 486 Ultra accepts the stapling positions in any order and would carry out the assembly in the order recorded (from Position 1 to 5), it is wise to memorise the stapling positions from outside to inside of frame, this would make the machine work faster and would create for the operator a bigger space to bring the corner out of machine.



Move the wedge distributor (Block H) to the outside across the moulding pressing on key until the wedge exit slot finds physically the position chosen (or marked with a pen). Now specify the quantity of wedges you want to insert (or stack on each other) by pressing repeatedly the **Q-key** until the quantity chosen is there ; in example above : 5.

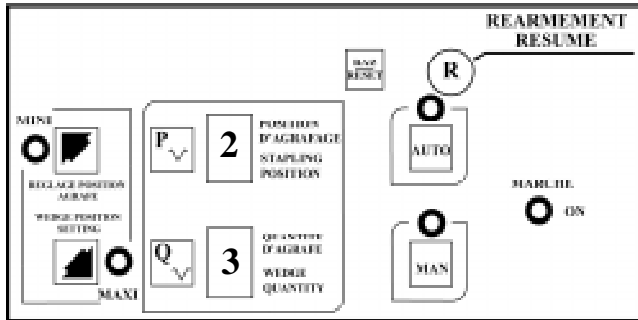
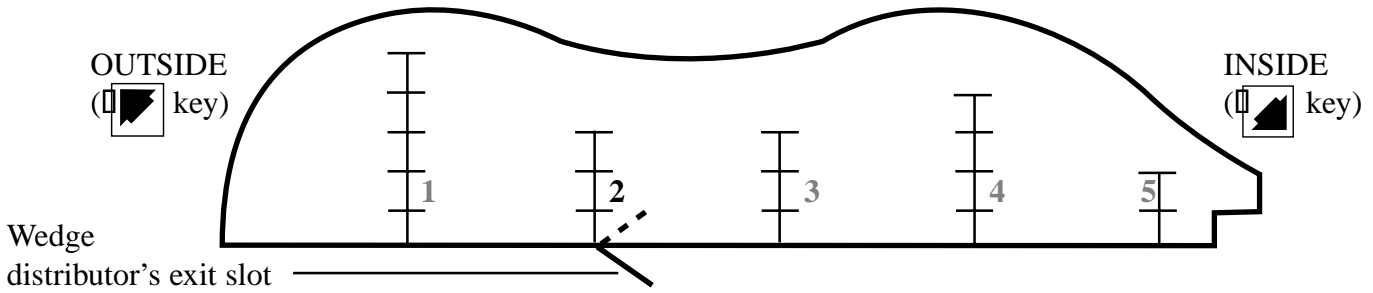

b) Second Stapling Position P 2

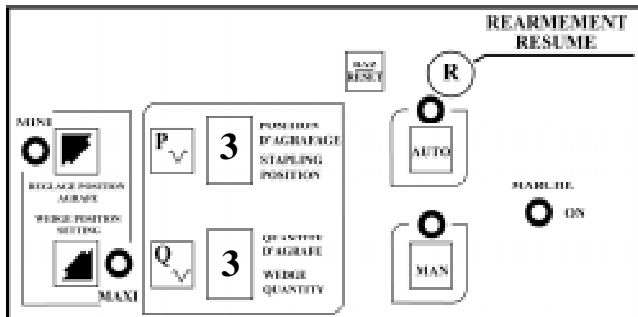
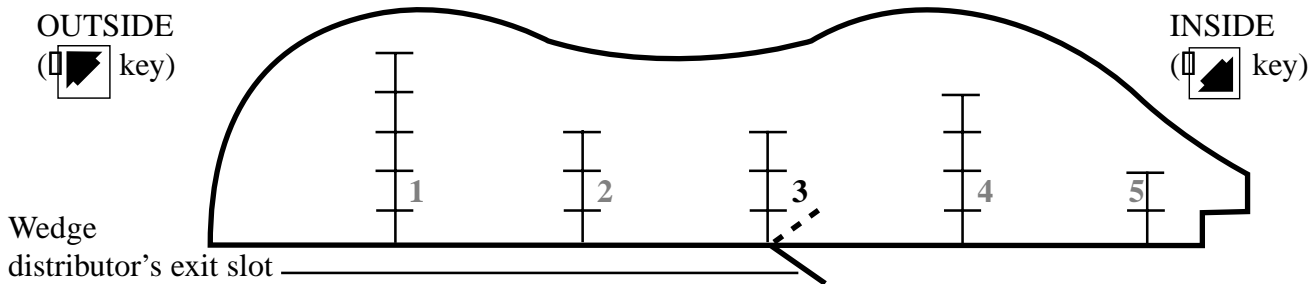

Press **P**-key to change it to P 2. Move the wedge distributor (Block H) across the moulding pressing on key  until the wedge exit slot finds physically the second position chosen, here to the inside of frame with  key. Now specify the quantity of wedges you want to insert (or stack on each other) by pressing repeatedly the **Q**-key until the quantity chosen is there ; in example above : 3.

c) Third Stapling Position P 3



Press **P**-key to change it to P 3. Move the wedge distributor (Block H) across the moulding pressing on key  until the wedge exit slot finds physically the third position chosen, here to the inside of frame with  key. Now specify the quantity of wedges you want to insert (or stack on each other) by pressing repeatedly the **Q**-key until the quantity chosen is there ; in example above : 3 again.

d) Repeat the same operation as in b) or c) above for the fourth and fifth stapling positions.

At the end, once all positions and wedge quantities are recorded, turn the **pre-clamp button PG** to OFF. This will make the rebate clamp come slightly back to create the space needed to bring out the corners without having to loosen the sliding table of the machine.

Notice : There is no rule or sense to be respected for the stapling positions ; P-1 can be close to the rebate of the frame, P-2 close to the outside, then the P-3 again closer to the rebate, etc. Your 486 Ultra accepts stapling positions in any order and would carry out the assembly in the order recorded (from P-1 to P-5). See advice below. There is no obligation to record all 5 positions P-1 to P-5 ; for a small profile only one or two positions will be sufficient ; the machine will carry out only the positions recorded.

ADVICE : There is no rule or sense to be respected for the stapling positions but, unless there is a special reason, it is advised to memorise the stapling positions from outside to inside of frame, this would make the machine work faster and would create for the operator a bigger space to bring the frames out of machine. In fact, sometimes this may not be possible with some too difficult profiles which oblige the operator to start in a specific area to prevent the mouldings from rocking ; this means the Position 1 may be in the middle, then a P-2 to the back and a P-3 for example to the inside ; the machine will carry out in the order recorded, making sure mouldings cannot rock. **TIP :** your 486 Ultra machine accepts stapling positions with 0 (zero) no wedges and will go to that position without inserting wedges there ; in this case the plunger will have enough time to come completely up. This ability of the machine is very useful for some special profiles –for instance like an L – to prevent from hitting the profile because of the speed when the machine goes from position to position to insert wedges.

ASSEMBLING FRAMES

Standing in the work position used as reference (Fig 2, page A), first put on the machine the left hand moulding chop that has been used to make up the settings for the assembly process (see chapters).

Place now the right hand chop in front of the right hand back fence B2 so that they form a corner.

To join them ; there is a choice between two Assembly Modes :

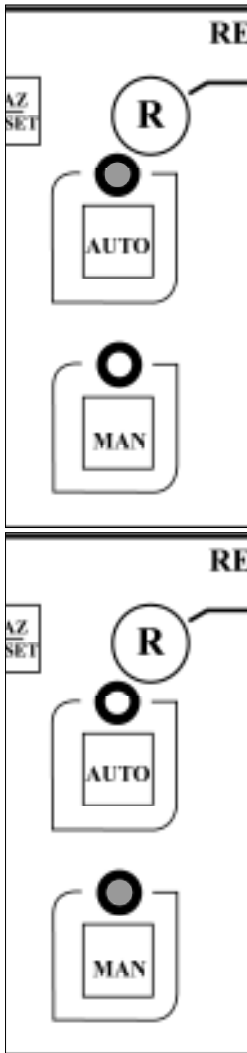

a) **AUTOMATIC MODE (AUTO) ; faster, more suitable for volume production.** *Automatic* means that the machine will carry out the whole cycle just by pressing on the foot pedal ; will clamp mouldings at their rebate + clamp them on top + will go throughout all the wedge positions recorded inserting all the wedges required.

To do so, Press **AUTO**-key ; the indicator lights up. Keeping mouldings well against each other, press on the foot pedal. **Do not release the foot pedal until the end of the cycle.**

b) **MANUAL MODE (MAN) ; more suitable for production with profiles changing often.** *Manual* means that by pressing on the foot pedal, the machine will only clamp mouldings at their rebate, so that the quality of the corner can be visually checked before inserting wedges. Then, by pushing on the stapling button DA, the machine will carry out all the rest of the cycle ; will clamp mouldings on top + will go throughout all the wedge positions recorded inserting all the wedges required.

To do so, Press **MAN**-key ; the indicator lights up. Keeping mouldings well against each other, press on the foot pedal. Check the quality of the corner ; if there is any opening on top or to the inside or to the back of the corner, proceed with the adjustments proposed (see those chapters) to remedy the problem. After any adjustment, press the foot pedal again to check the corner once more. If the quality is satisfactory, press on **stapling button DA** (Fig.1 page A) to finish the assembly of the corner. **Do not release the foot pedal until the end of the cycle.**

ADVICE : When you start with a new moulding or profile, join the first corner in MANUAL mode to adjust perfectly the backfences, assembly angle etc by clamping the mouldings and seeing the result without inserting wedges yet. Then for the following corners or frames, change to AUTOMATIC. If all these moulding chops were cut on the same cutting machine, the machine will give you every time exactly the same result as the first corner.

NOTICE :

- While the assembly of the corner is carried out by the machine, the stapling positions and the quantity of wedges to be inserted light up as and when proceeded.
- At the end of the assembly, if more than one stapling positions has been carried out, the top presser plunger of the machine initialises itself and goes to the first position, ready for the next corner.
- If the **clamp safety indicator (SS)** (see Fig.1, page A) lights up, this means the machine is not clamping the mouldings well ; (the reason may be that the table was not tightened well and went slightly backwards) if this lights up before the start of a cycle -when pushed on foot pedal, the cycle will not be carried out, not to waste mouldings with a bad assembly.
- But if the **clamp safety SS** lights up while an assembly cycle is in progress –for instance if the table with mouldings slides away progressively, while the assembly is being carried out-, the machine will continue the cycle to the end.

MAINTENANCE

**BEFORE ANY INTERVENTION,
UNPLUG THE POWER SUPPLY AND CLOSE THE AIR VALVE.**

To prevent your machine from ageing prematurely by lack of maintenance, your Cassese 486 Ultra machine is equipped with a Periodical Maintenance and easy Trouble Diagnosis System which is introduced by the machine as ERROR messages on its keyboard : **the letter E** lights up in the stapling positions (P) section of the keyboard followed by **a number** from 0 to 8 in the wedge quantity (Q) section.

After proceeding with the maintenance required, press on **RESET-key**

E-0 : means **PLEASE PROCEED WITH REGULAR MAINTENANCE OF WEDGE DISTRIBUTION**

Your Cassese 486 Ultra is equipped with an internal counter to request periodical maintenance : Each time a total of 50,000 wedges has been inserted by the machine, this message comes up.

- Remove the wedge cartridge from machine.
- With hexagonal Allen key # 3mm (accessory box) loosen the locking screw of Block H (wedge distributor).
- Remove Block H from machine and clean it with blowing air ; no need to dismantle it.
- Before putting back into machine, put a little quantity of grease (supplied with machine) into its down hole, for the lubrication of the hammer (driver blade of the machine that pushes up the wedges).
- When putting back Block H into machine, make sure the its window is facing the cartridge side.
- And before tightening the blocking screw, check the height of Block H ; touching with your thumb, check that it is flush with the table of the machine.

TO SWITCH OFF THE MAINTENANCE LIGHT

PUSH AT THE SAME TIME ON :



E-1 : **PLEASE CHECK TOP PRESSER**

- Either the distance between the top presser and the stapling area of the moulding is more than maximum 50mm (2") allowed ; if so please reduce the distance using a longer top presser pad.
- Or the top presser is coming down too slowly ; in this case increase the speed with the top presser speed adjuster (Fig.1, p.A)

In these two cases a wedge may be half engaged in the wedge distributor (block H) : proceed as follows :

CLEARING OF A WEDGE HALF ENGAGED IN WEDGE DISTRIBUTOR

During assembly, one or more wedges may get stuck in the wedge distributor (block H).

- Switch off the power and close the air valve.
- Try to remove the cartridge that is on machine.
- If it resists, use the wedge pusher tool (in accessory box) to replace the wedge back in cartridge.

**-In case of hammer and wedge jamming,
see the following section (3)**

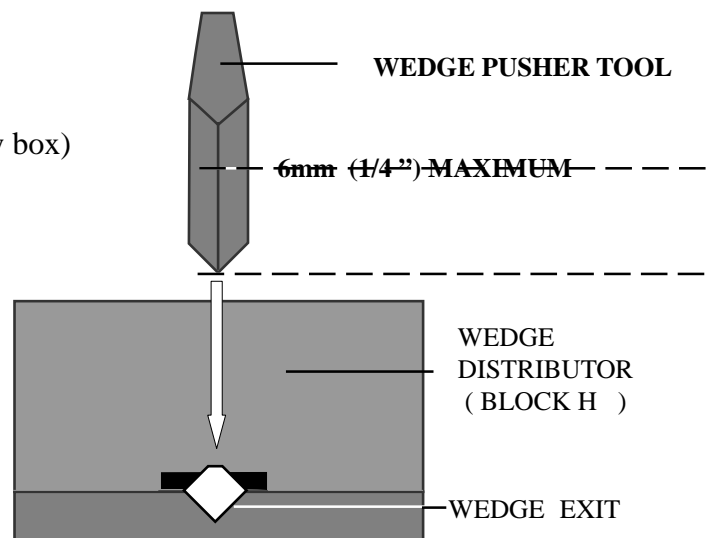

IN CASE OF HAMMER & WEDGE JAMMING

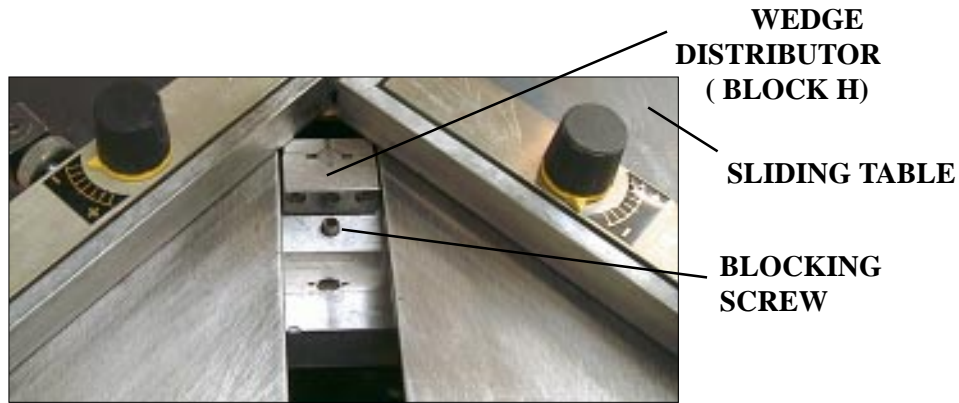

SCREW POSITIONS OF BLOCK H

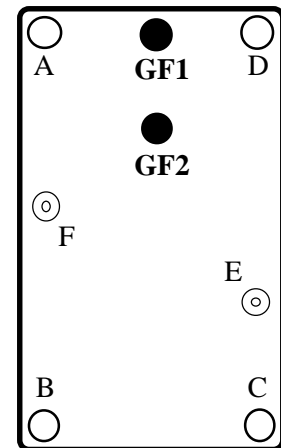

In case of the hammer (wedge driver blade) and a wedge jamming in the wedge distribution block, proceed as follows, **after having unplugged the machine from mains supply and closed the air valve.**

-Remove the wedge cartridge from machine.

-With the 3mm allen key (supplied with machine), loosen (no need to remove) the blocking screw of block H (see above).

-Remove the block H from machine and check:

1) If there is no wedge or hammer stuck inside it, put it back in machine.

2) **If the hammer (like a very long wedge, approx. 8cm (3'') long) is stuck in it**, we need to open the block H to get rid of the old hammer: Use for this the smaller (2.5mm) Allen key (supplied with machine) and remove the 2 central screws (see above GF1 & GF2) that hold the fixed (square) guide of Block H in place. Remove the fixed guide completely to free the old hammer. If still not possible to get rid of the old hammer, remove the 4 corner screws (A-B-C-D) and open the block H. Two factory set locator pins E & F allow the plates to be re-positioned precisely again.

Remove the old hammer. Assemble the block H back again.

PUTTING A NEW HAMMER

-Put a drop of grease (tube of grease supplied with the machine) in the bottom hole of the wedge distributor (block H).

-Insert a new hammer into the wedge distributor from the top, with the hole of the hammer downwards.

-Re-position the wedge distributor in its housing on the machine, with the window towards the cartridge.

-If the upper end of the new hammer stays out of block H, push it fully in with a piece of wood or moulding.

-Now, connect the machine to air (must be 6-7 bars = 100 psi) and to power. Turn the start button to start and press **R-key (RESUME)** on the keyboard.

-Put any of the top presser ends (triangle or round rubber) on the machine and place a piece of flat moulding or corner on the block H, under the top presser. (The distance between the top presser and the moulding should not exceed 50mm (2'').)

-Check that the **Pre-clamp button PG** is OFF ; now, keeping the **RESET-key** pressed, press at the same time also on the **Stapling Button (DA)** ; indicator lights blink.

-Approximately, 1 second later the top presser plunger comes down and simulates a stapling ; the hammer must have taken automatically its place in the mechanism.

AFTER ANY INCIDENT, IF THE HAMMER (driver blade) REMAINS STUCK IN WEDGE DISTRIBUTOR (Block H), REPLACE IT BY A NEW ONE TO ELIMINATE THE RISKS OF FURTHER JAMMINGS AND DAMAGING OTHER PARTS.

E-2: START OF TRAVEL SWITCH IS DEFECT (GIVING SIGNAL CONTINUOUSLY)

This is an internal part needed by the machine to carry out its joining cycles correctly.

Solution : contact your regular supplier of Cassese products for technical help.

E-3: END OF TRAVEL SWITCH DEFECT (GIVING SIGNAL CONTINUOUSLY)

This is another internal part needed by the machine to carry out its joining cycles correctly.

Solution : contact your regular supplier of Cassese products for technical help.

E-4: START OF TRAVEL SWITCH DEFECT (GIVING NO SIGNAL)

Solution : contact your supplier of Cassese products for technical help.

E-5: END OF TRAVEL SWITCH DEFECT (GIVING NO SIGNAL)

Solution : contact your supplier of Cassese products for technical help.

E-6: YOU ARE TRYING TO START A CYCLE (i.e. FOOT PEDAL PRESSED) WHILE THE PRE-CLAMP BUTTON PG IS STILL ON

Solution : Turn **Pre-clamping Button PG** (see Fig.1, page A) to OFF. Press **RESET** and then start the cycle again.

E-7: means PLEASE PROCEED WITH PREVENTIVE MAINTENANCE OF OTHER MOVING PARTS OF THE MECHANISM

Your Cassese 486 Ultra is equipped with an internal counter to request periodical preventive maintenance : Every time the machine's mechanism (the wedge distributor and top presser) has moved a distance of 5 km (about 3 miles), the machine reminds the operator to make a short maintenance to prevent moving parts from wearing and ageing too fast.

(See picture next) Top presser plunger (P) must be a little lubricated, using a SAE 20/40 oil.

Before turning the machine on again, make the mechanism move by hand back and forth several times to diffuse the lubrication.



TO SWITCH OFF THE MAINTENANCE LIGHT

PUSH AT THE SAME TIME ON :



E-8: means INSUFFICIENT OR NO AIR PRESSURE (below 6 bars = 85 psi)

Please check that the source of compressed air is supplying the pressure needed; check the arrival hoses and make sure that the air valve of the machine is turned ON.

You get this error message also if you turn on the power before air on the machine. Once the problem is solved, press **RESET** to cancel the error message.