



Quality for the world

CS 3099

NUMERIC UNDERPINNER



Technical and User Manual

11/99

Sté CASSESE , Zone Industrielle - Verneuil l'Etang - 77390 - FRANCE
Tel : + 33.1.64424971 / Fax : +33.1.64425894
Web : www.cassese.com / e-Mail : Cassese.xp@wanadoo.fr

GETTING FAMILIAR WITH YOUR CS 3099

Fig 1

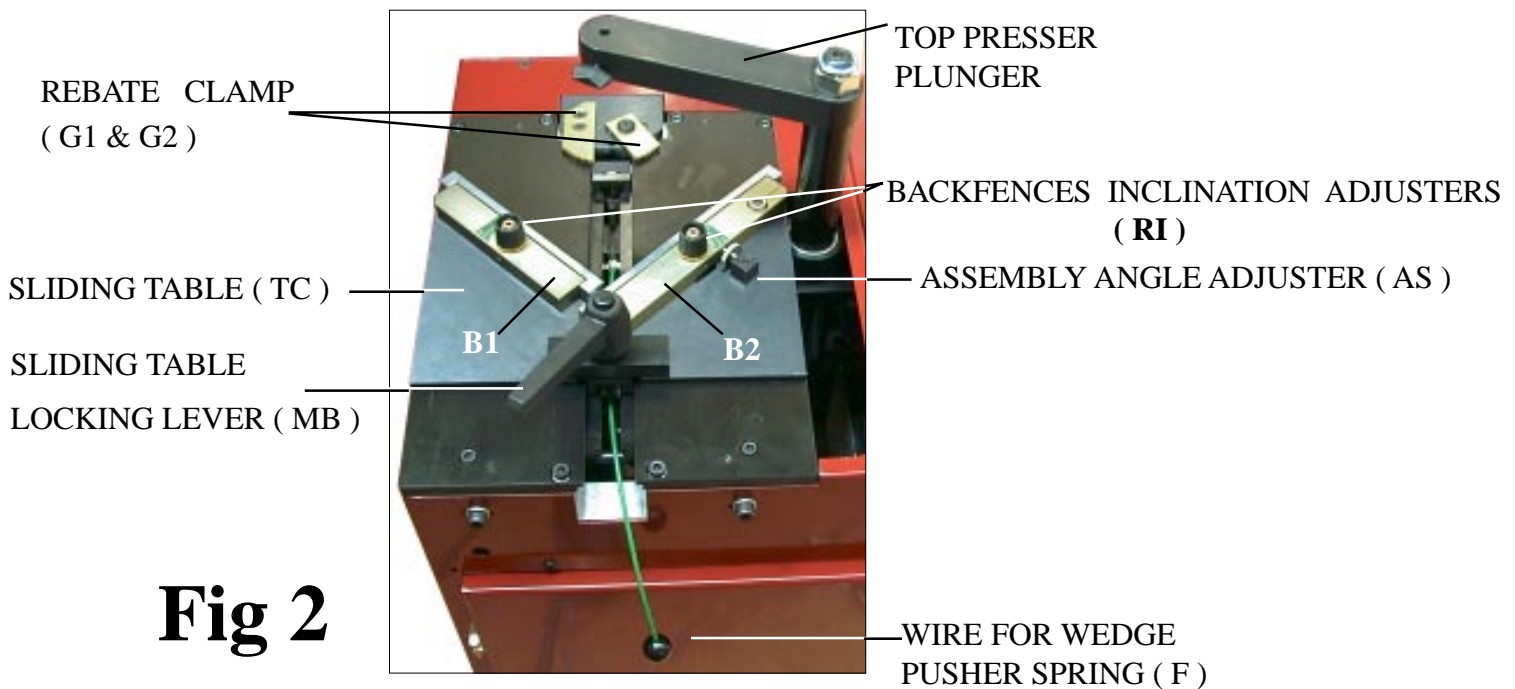
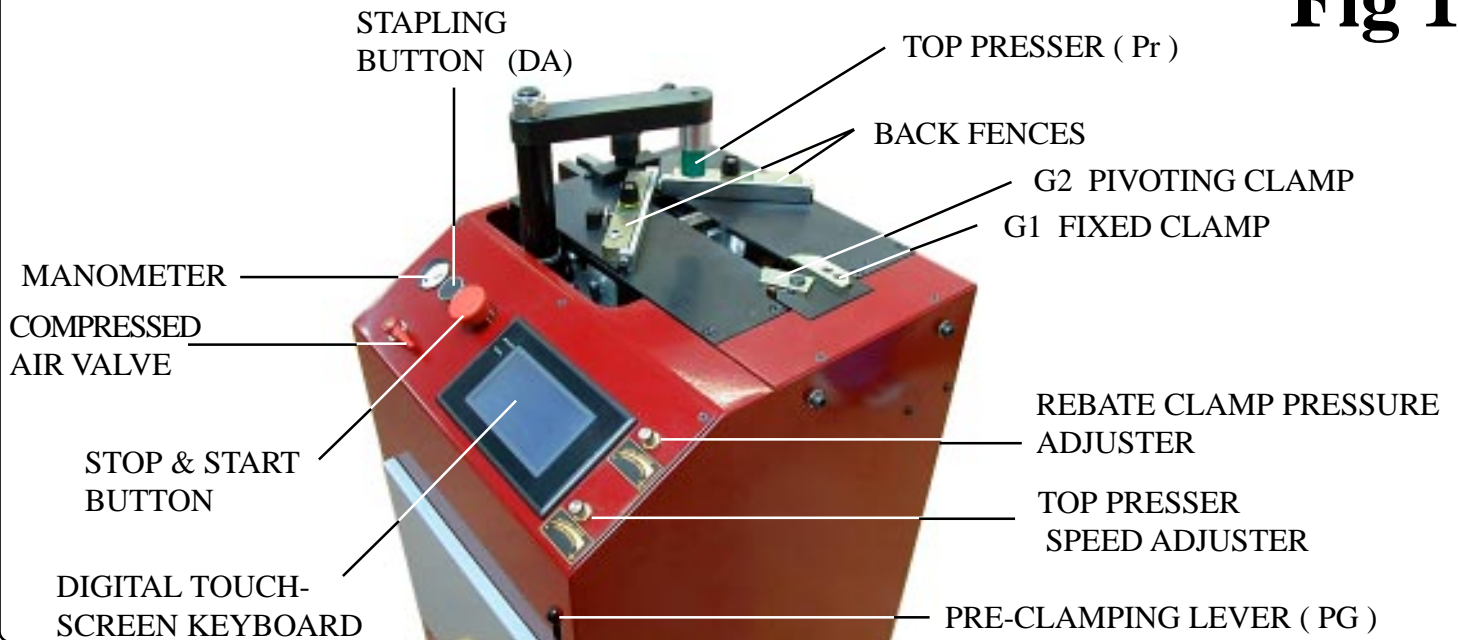

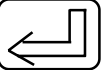



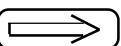



Fig 2

| | | |
|--------------------------------------|---|--|
| TOUCH SCREEN SYMBOLIC BUTTONS |   | SELECTION OF VALUE BY REPEATED PUSHES |
| |  | RECORD OF ANY NUMERIC VALUE |
| |  | RECORD OF ALL VALUES ON A SCREEN |
| |  | TO CLEAR A VALUE |
| |  | TO RETURN TO PRECEDENT MENU |
| |  | or "NEXT" TO GO TO NEXT MENUE |
| |  | HELP (EXPLANATIONS) |

FUNCTION PARAMETERS

IMPORTANT

On MAIN MENU, press:

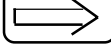
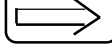
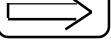
MAINTENANCE / on INPUTS screen, press  / then  again / CAUTION message, press  again / you have reached the screen of machine's function

PARAMETERS

| | | | | |
|----------------------|----------|--------|-----|---|
| LANGUAGE | ENGLISH | 1 | 2 | 3 |
| MANUAL MODE | MINIMUM | 4 | 5 | 6 |
| EXECUTE IN | PREVIOUS | 7 | 8 | 9 |
| WEDGES OFFSET | 0000 | 0 | CLR | |
| PIN CODE | 0000 | | ↓ | |
| | | RETURN | ← | |

LANGUAGE : You can change the active language by pressing on LANGUAGE.

MANUAL MODE

While executing (assembling frames), your CS 3099 can work on 3 different manual modes:

- MINIMUM (MANUAL)**: the foot pedal pushed + by pushing the stapling button once, the whole joining cycle is carried out.
- MEDIUM** : by pushing the stapling button, all the wedges of only one stapling position are inserted.
- MAXIMUM (MANUAL)**: The cycle is fully detailed; the stapling button must be pushed each time to insert one wedge.

EXECUTE IN:

Here, by pressing on the key, you can preset the PRIORITY Execution Mode of the machine amongst 3 modes:

MANUAL : Machine proposes you Manual execution in priority. See manual modes above.

AUTOMATIC: When executing, the machine proposes Automatic Mode in priority. In automatic mode, pushing on foot pedal, the whole assembly cycle is carried out.

PREVIOUS: Machine proposes you the last mode used when executing; may be manual or Automatic.

OTHER PARAMETERS:

Pushing key β on screen, each parameter can be modified.

Values in WEDGE OFFSET are factory set for each machine; do not modify them, unless requested by your supplier of CASSESE products.

PINCODE

Your CS 3099 is equipped with 2 pin codes that prevent the operator to access to certain menus:

CODE 2802 disactivates both access to JOINING FILE and to EXECUTE DIRECTLY so no article can be cancelled, modified or added to the memory. Nor can be joined any moulding that is not in File.

CODE 2803 blocks the access to EXECUTE DIRECTLY only, so that no moulding that is not in file can be assembled or no mouldings in file can be assembled with modifications of its joining parameters.

To activate a pin code, enter it and validate by pressing .

To cancel a pin code, enter it again and validate by pressing .

RETURN brings you back to MAIN MENU of the machine.

PROGRAMME OF CS 3099

INTRODUCTION SCREEN

MAIN MENU

JOINING FILE

MAINTENANCE

CREATE

MODIFY

ERASE

LIST OF ARTICLES

INPUTS

OUTPUTS

EXECUTE

PARAMETERS

EXECUTE FILE

EXECUTE DIRECTLY

HAMMER CHANGE

MOULDING PARAMETERS

LANGUAGE

SPACER

MANUAL MODE

AUTOMATIC / MANUAL

EXECUTE IN

WEDGE OFFSET

45°
30°
22.5°

PINCODE

CONTENTS

| | PAGES |
|--|----------|
| <u>IMPORTANT</u> | |
| - GETTING FAMILIAR WITH YOUR CS 3099 | A |
| - TOUCH SCREEN SYMBOLIC BUTTONS | A |
| - FUNCTION PARAMETERS | B |
| - PROGRAMME OF CS 3099 | C |
| <u>INTRODUCTION</u> | |
| - ACCESSORIES | 1 |
| - SPECIFICATIONS | |
| - OPTIONS | |
| - GUARANTEE | |
| <u>INSTALLATION</u> | |
| - PREPARATION | 2 |
| - CONNECTING TO COMPRESSED AIR SUPPLY | |
| - CONNECTION TO POWER SUPPLY | |
| <u>PUTTING INTO OPERATION</u> | 3 |
| <u>ADJUSTMENTS-</u> | |
| - CHOICE OF A TOP PRESSER | 4 |
| - USE OF THE SET OF SPACER BARS | 4 |
| - ADJUSTING THE SLIDING TABLE | 5 |
| - ADJUSTING THE INCLINATION OF THE FENCES | 5 |
| - ADJUSTING THE ASSEMBLY ANGLE | 6 |
| <u>USE</u> | |
| - MEANS OF ASSEMBLY | 7 |
| - LOADING & CHANGING THE WEDGE CARTRIDGE | 7 |
| - SELECTION OF STAPLING POSITIONS | 7 |
| - PREPARATION FOR PRESET RECORDING | 8 |
| - PRESET RECORDING | 8-9 |
| - EXECUTION (JOINING) OF AN ARTICLE | 9-10-11 |
| - PRESET RECORDING OF AN ARTICLE WITH MULTIPLE (UP TO 6) STAPLING POSITIONS | 11-12 |
| - MODIFICATION & CANCELLATION OF AN ARTICLE | 13 |
| - SCREEN MESSAGES – FAULTS AND REMEDIES | 14 |
| <u>MAINTENANCE</u> | |
| - LUBRICATION / CLEARING OF A WEDGE HALF ENGAGED IN THE MACHINE | 15 |
| - IN CASE OF HAMMER JAMMING (wedge driver blade) | 16-17 |
| - PARTS LISTS & DRAWINGS | |

INTRODUCTION

You have just bought a CS 3099 numeric frame joining machine, so we congratulate on your sensible choice and thank you for your trust in Cassese products.

The CS 3099 benefits from the experience of the joining machines that brought Cassese a certain reputation. It makes it possible to join wooden mouldings of all profiles (patent n° 7522814).

The CS 3099 is designed to allow the operator to move all around the machine.

The joining operation is carried out by using metal wedges especially designed to perform a tight join. These wedges come in throw-away plastic cartridges, without glue, individually lubricated and rust-protected for the toughest challenges.

**IMPORTANT : Do not use any other wedge cartridges but genuine Cassese cartridges.
(registered mark CS).**

ACCESSORIES SUPPLIED WITH THE MACHINE

The CS 3099 comes with a cardboard accessory box that contains:

- 1 Trapdoor key
- 1 quick release female air connector
- 1 triangle support with 1 black rubber triangle (hard) +1 white triangle (soft)
- 1 round rubber support with - according to mouldings shape and height:
- 2 green rubber ends for hardwood types (1 short and 1 long)
- 2 yellow rubber ends for soft wood types (1 short and 1 long)
- Spacer bars for small mouldings.
- 1 spare hammer (wedge driver blade)
- 1 tube of grease
- 2 Allen keys for hexagonal nuts (2,5 - 3 - 5 mm) / 1 wedge pusher tool
- 4 feet with the washers & nuts needed

TECHNICAL SPECIFICATIONS OF CS 3099

- Minimum moulding width : 3 mm ($\frac{1}{8}$ ") - maximum width : 130 mm ($5\frac{1}{4}$ ")
- Minimum dimensions of a frame : 85 mm x 85 mm visibly ($3\frac{1}{2}$ " x $3\frac{1}{2}$ ").
- Wedge sizes in cartridges of 275 pieces : 5, 7, 10, 12 and 15 mm. On special order size #4 and #3 are also available.
- Two wedge types : for soft and for hardwoods. Don't use Hardwood wedges on softwoods.
- Machine weight : 100 kg (222 lbs)
- Dimensions : Width 48 cm (19") x Depth 44 cm ($17\frac{1}{2}$ ") (without optional rotating table)x
Height 114 cm (45")
- Power supply : | Electric : 220 V or 110 V single phased, 50/60Hz, Consumption 500 W.
 | Pneumatic : compressed air 7 bar (100 psi). Average consumption: 5 litres / cycle.
- Air preparation : pressure reducing valve + manometer, connecting pipe, inside diameter 8 mm.

OPTIONS

- Independent rotating table, diameter 1300 mm ($50\frac{1}{4}$ ") to make the handling of large frames easier (frame dimensions not exceeding table diameter). Cassese Item # Z.3074.
- Set of furniture clamps to join mouldings without rebate and/or small frames. Item # Z.2763.
- Angle inserts for 6-sided frames (Item Z.3204), for 8-sided (Z.3203) or for other forms on request.
- Bar code scanner system (item Z.3471).
- File memory copier software from 3099 to a new 3099 (item Z.4999).

GUARANTEE

One year guarantee for parts and labour against manufacturing defects. Wear parts and those damaged as a result of non appliance with the instructions of the present manual are excluded from the guarantee.

INSTALLATION

To avoid damages due to vibrations during transit, your CS 3099 comes with a piece of wood located between the wedge distributor and the sliding table Tc. To remove it, loosen Mtc (Sliding table locking lever) and slide the table Tc backwards.

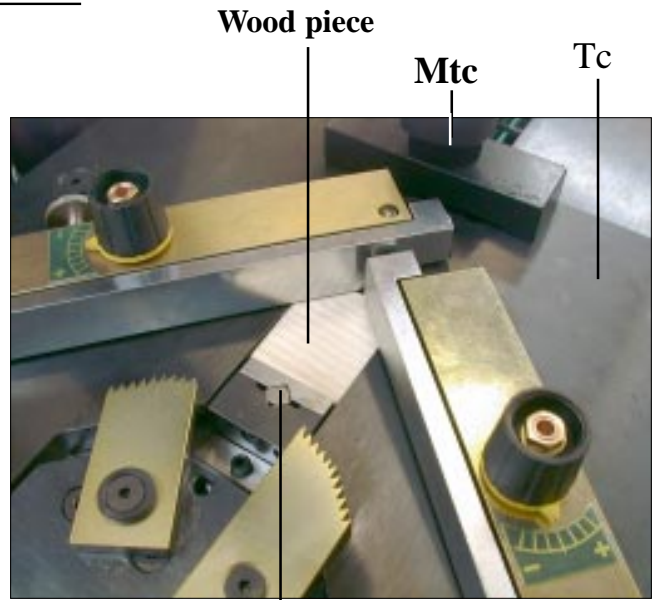

Wedge distributor

Reassemble the four feet of the machine supplied among accessories and adjust the level of the machine to your floor so that the machine vibrates or moves as little as possible which is the most important reason for fast mechanical ageing of all equipment.

CONNECTING TO COMPRESSED AIR SUPPLY

Open the access trap of the machine with the trapdoor key supplied. Inside the machine (see picture), connect the compressed air arrival by using the quick release female connection supplied with the machine also. Make sure pressure supplied by your compressor is equal or above **7 bars (100 psi)**.

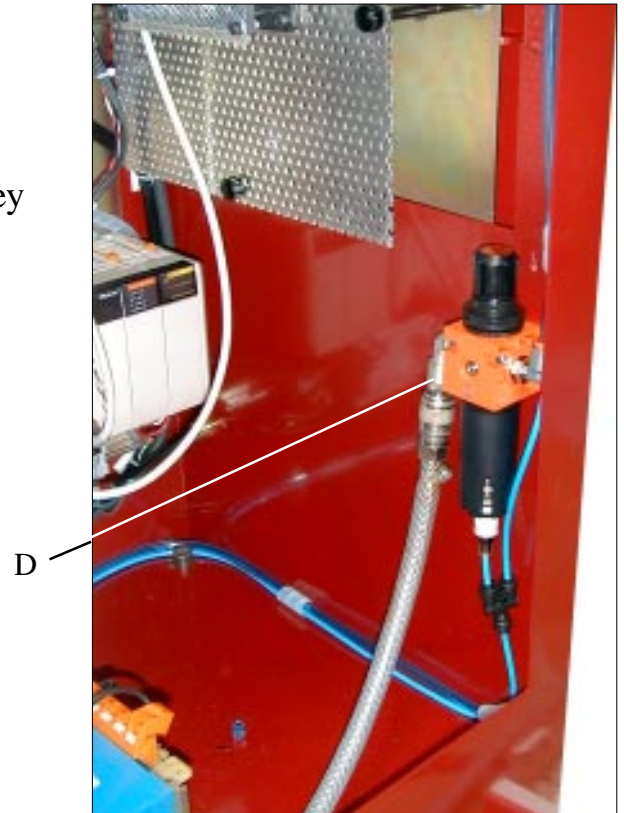

CONNECTING TO POWER SUPPLY

Connect the CS 3099 to a 220 V (110 V in North America & Japan) single phased grounded electrical socket.

PUTTING INTO OPERATION

Turn on the compressed air valve. The pressure shown on manometer should be 7 bars. If your compressor is sending out a higher pressure but the manometer is showing less, increase the pressure at machine's regulator -where the air arrival is connected.

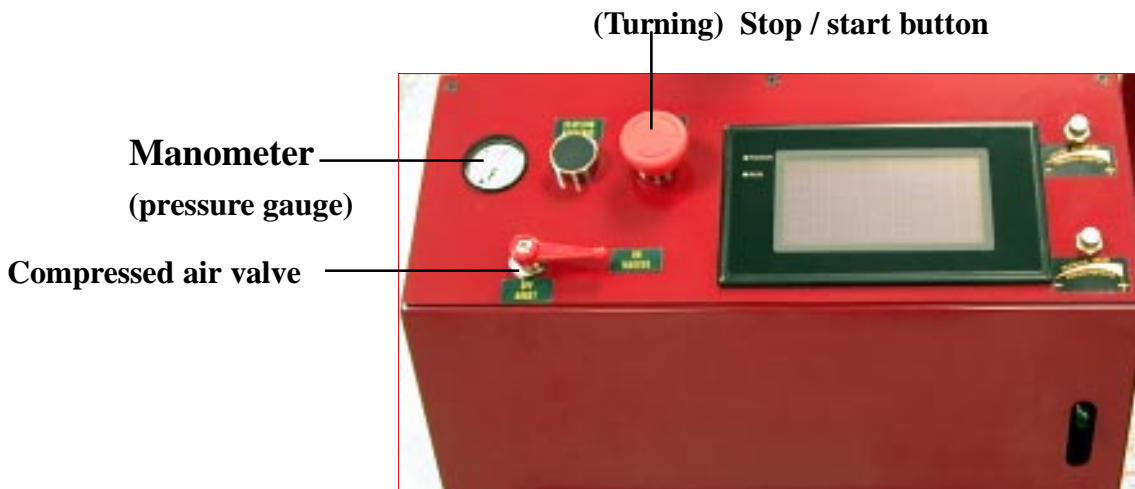

Turn the red Start/Stop button so that it comes up to START position.

The following introduction screen comes up:



**ZONE INDUSTRIELLE - 77390
VERNEUIL L'ETANG - FRANCE**
tel : 33164424950 fax: 33164425890

UNDERPINNER

CS 3099

CYCLES : 00000055 WEDGES : 00000082

VERSCR: 01.01 VERPROG : 01.00

TOUCH THE SCREEN TO CONTINUE

Number of cycles carried out by the machine since day 1.

Number of wedges inserted by the machine since day 1.

Depending on the quantity of stapling positions for each item, your CS 3099 can keep in memory more or less articles.

The more there are stapling positions per item, the smaller becomes the number of items the machine can keep in its File manager. For information,

MAXIMUM ARTICLE (Item or Profile) QUANTITIES & STAPLING POSITIONS PER ITEM

| Qty of stapling positions per article (item or profile) | 1 | 2 | 3 | 4 | 5 | 6 |
|---|------|------|------|-----|-----|-----|
| Qty of items CS 3099 can memorise in File | 1500 | 1200 | 1000 | 857 | 750 | 660 |

ADJUSTMENTS

SELECTION OF A TOP PRESSER END

Make sure that the distance between the moulding's top and the presser's bottom is not more than 50 mm (2").

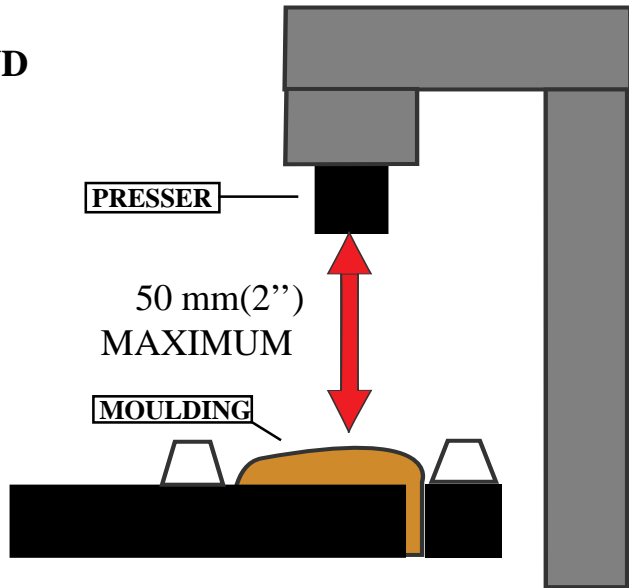

If the distance is bigger, use a longer top presser end. For very tall mouldings the round rubber tips can be also inserted into the top presser bracket without their support to gain capacity in height.

| | | |
|-------------------------------|----------------------|---------------------------|
| BLACK TRIANGLE PRESSER | FOR HARDWOODS | mounted on support |
| WHITE TRIANGLE PRESSER | FOR SOFTWOODS | with a 2.5 mm Allen key |
| GREEN RUBBER TIPS | FOR HARDWOODS | 1 long and 1 short |
| YELLOW RUBBER TIPS | FOR SOFTWOODS | 1 long and 1 short |

Triangle top pressers are good for flat mouldings or for mouldings presenting a flat or horizontal area to come down on. The round rubber ends are good for complicated forms (uphill, downhill or reverse mouldings).

USING THE SET OF SPACER BARS

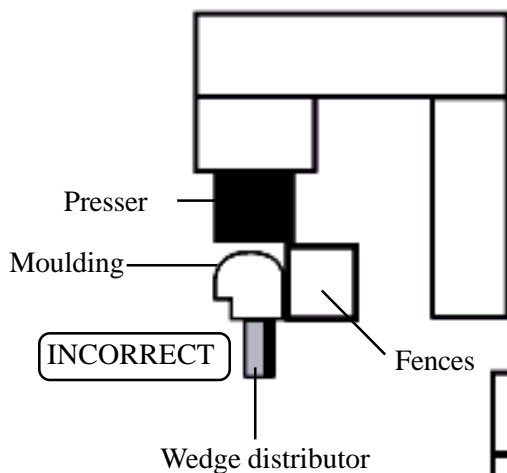

In case you have to join small mouldings with a smaller height than the fences, you must put the spacer bars between the mouldings and the fences to create a distance.

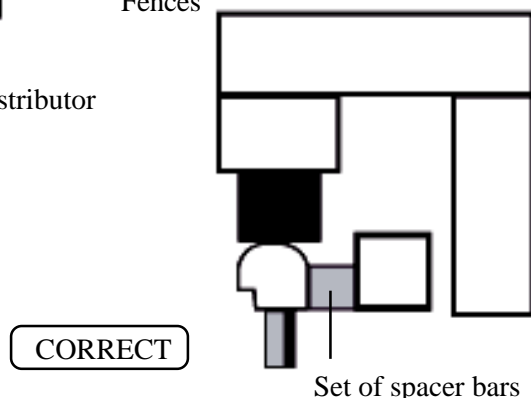

ADJUSTING THE SLIDING TABLE TO THE MOULDING

- 1) On MAIN MENU, press EXECUTE, then EXECUTE DIRECTLY., then EXECUTE. The machine will ask you to PLS ADJUST THE TABLE. Now press down the pre-clamping lever PG (Fig 1 page A). This will make slightly advance the rebate clamp of the machine G1 & G2 (Fig 1).
- 2) Make sure that the knobs of backfences inclination adjusters RI (Fig 2, page A) are at 0 (zero).
- 3) Position a moulding against left hand fence B1 (for mouldings with a height smaller than the fence, use the spacer bars supplied with the fittings by slipping them between the fences and the small mouldings).
- 4) Move sliding table TC (fig2 pA) forward as far as the moulding comes into contact with the clamp G1 (fig1, pageA).
- 5) Tighten the sliding table blocking handle MB (fig2,pA).
- 6) Now you can bring the lever PG up again.

ADJUSTMENT OF THE INCLINATION OF THE FENCES

ADJUSTMENT KNOBS (RI) FOR
THE INCLINATION OF THE FENCES

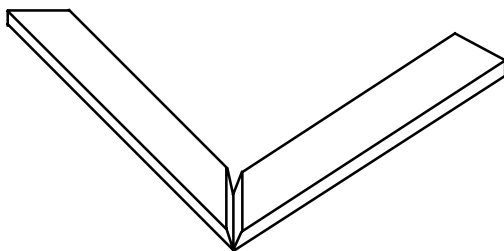
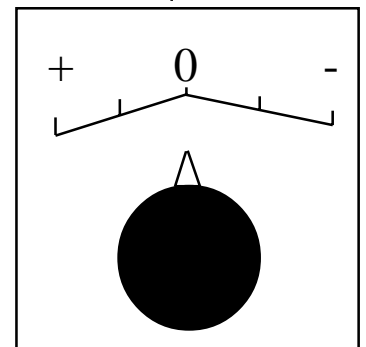
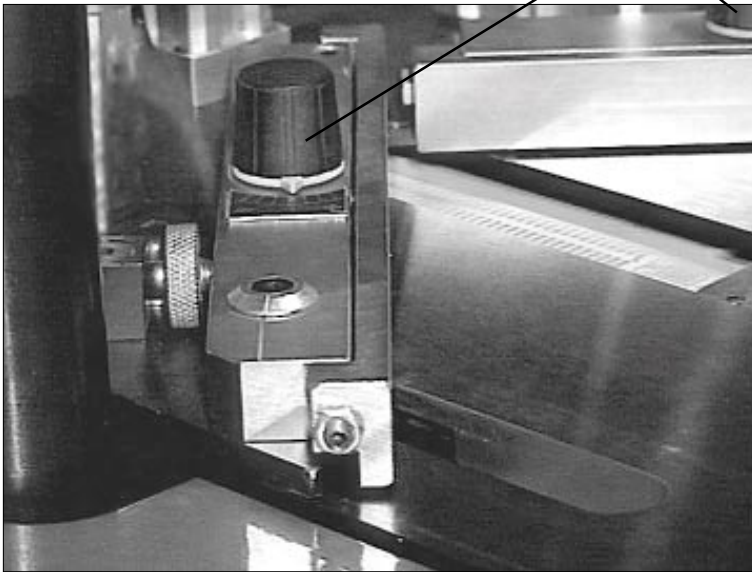

If the corner has an opening **on top**, turn the two adjustment buttons (RI) an identical value to the MINUS (-) (see above picture) until the opening disappears when mouldings are clamped.

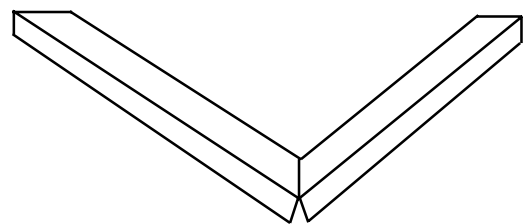

If the corner has an opening **underneath**, turn the same two adjustment buttons (RI) an identical value to the PLUS (+) until the opening disappears when mouldings are clamped.

ADJUSTMENT OF THE ASSEMBLY ANGLE

If several cutting machines are being used in your production or if you receive your mouldings already cut by your suppliers (chop service), the angles of the mouldings will be slightly different from one cutting machine to the other. The wider the moulding the more visible will be this angle difference. This is why the joining angle of your CS 3099 can be adapted to find precisely the cutting angle of your cutting machine.

If the corner is open towards outside, (standing behind the machine) screw in the adjustment screw AS (see picture below) to correct the fault and check the quality of the angle by clamping the corner again.

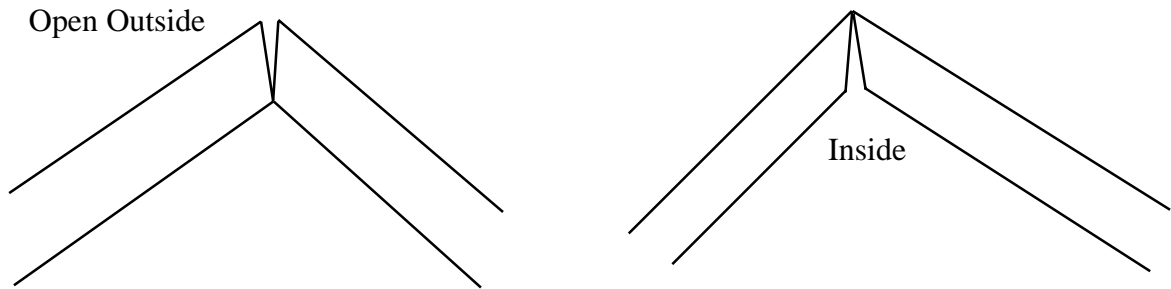

If the corner is open towards inside, unscrew the same angle adjuster AS to correct the fault and check the quality of the corner by clamping the mouldings again.

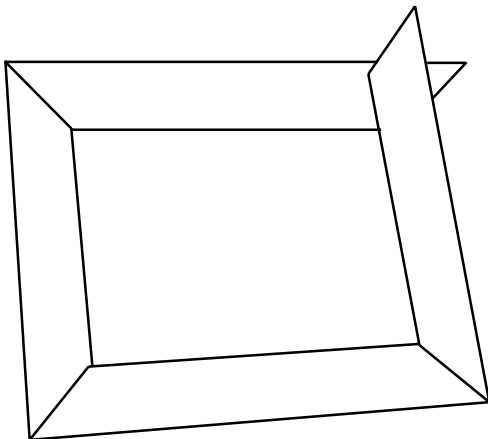

In the event of such a result, check your cutting angle that is actually bad because under 45° .

Have the angle of your cutting machine corrected, as it is impossible to make a rectangle frame with angles smaller than 90° .

(AS) SETTING SCREW FOR
THE ASSEMBLY ANGLE



USE MEANS OF ASSEMBLY



The joining is performed by using metal wedges, a Cassese invention, designed to ensure very tight corners. Five sizes are available : 5, 7, 10, 12 and 15 mm. They come in throw-away cartridges that are colour-coded per size for easy identification. Cartridge wedges exist in two versions : NORMAL for soft and normal timbers and HW for very hard timbers. These hardwood wedges are to be used only on hardwoods. Your CS 3099 machine is designed to use all sizes of Cassese cartridges without having to change any parts on the machine or having to adjust anything.

For the long term performance and reliability of your CS 3099, only use genuine CASSESE cartridges.

Beware of copies that would cause technical problems and would age your machine prematurely.

LOADING AND CHANGING THE WEDGE CARTRIDGE ON MACHINE

Pull the wire with ball of the wedge pusher spring **F** (fig.2, page A) fully out.

If there is a cartridge on machine, holding the wire pulled out, remove it by simply sliding out the cartridge.

Holding the wire pulled out, put a new cartridge on machine and pay attention that it is fully inserted in the wedge distributor's window.

Release gently the wire with ball of the wedge pusher spring **F**.

SELECTION OF STAPLING POSITIONS

The CS 3099 is designed to join mouldings in 1 to 6 places (positions) with 1 to 9 wedges in any of those places. In the case of several wedges in the same position, they will penetrate the wood pushing the previous wedge(s) deeper inside. The selection of the size of wedge to be used and the number of positions depends on the width and thickness of the moulding to be assembled.

As a general rule, the joining must be carried out as close as possible to the thickest (highest) parts of the mouldings.

A MINIMUM of 2 mm clearance (approx. 1/8") above the wedges shall be respected. The harder the wood timber, the more should be this clearance to prevent the moulding from cracking.

Example

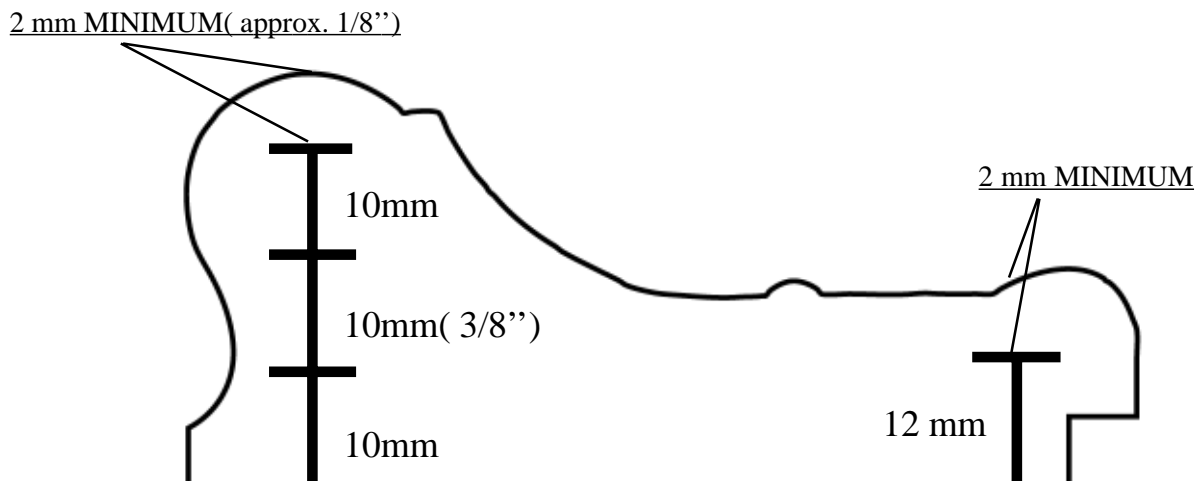

PREPARATION FOR PRESET RECORDING

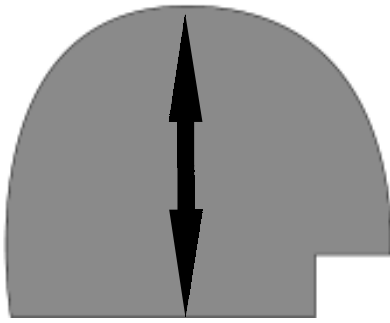

The highest portion of this moulding gives the best position for stapling.

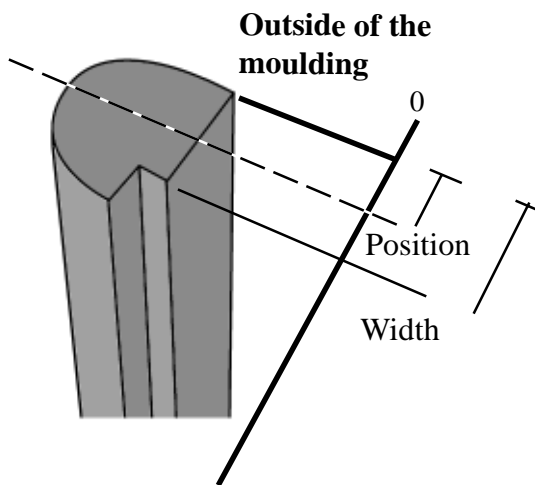



The width of the moulding -without the rebate- and the stapling position (for the wedge) are measured in millimetres perpendicularly (at 90°) to and starting from the outside of the moulding.

The CS 3099 can keep in memory article numbers that can contain up to 7 numeric digits. (This may be -depending on your choice- your profile or moulding or a completely new item number.)

RECORDING OF AN ARTICLE

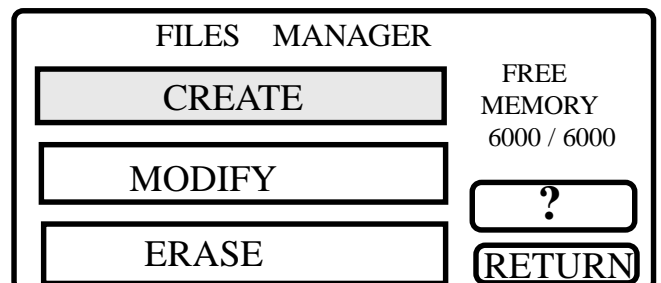
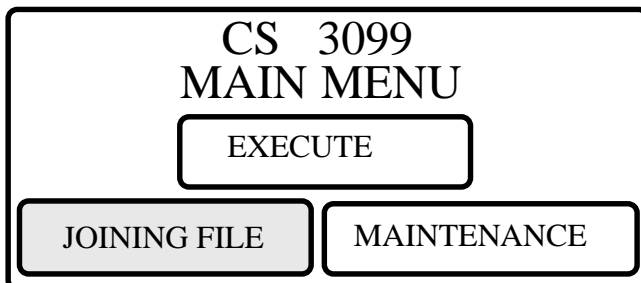
To create an article containing all the assembly data for a type of moulding, on MAIN MENU, press JOINING FILE key, then CREATE.



Every numeric information should be confirmed with the key . Otherwise the keyboard will keep the previous information which may be simply 0 (zero).

| | | | | | |
|----------------------|--|--|---|-----|---|
| JOINING FILES | | | 1 | 2 | 3 |
| | | | 4 | 5 | 6 |
| REFERENCE TO CREATE | | | 7 | 8 | 9 |
| 0000300 | | | 0 | CLR | |
| | | | | | |
| RETURN | | | ? | | |

STEP 1

-Enter the number on screen (1 to 7 digits) you want to give to this moulding or profile. In case of mistake, press CLR and start again. Confirm with ϵ .

-Page 1 of the Joining parameters comes up.

-RETURN key brings you back to FILE MANAGER menu.

| | | | | |
|------------------|---------|-------|-----|----------|
| REFERENCE | 0000300 | 1 | 2 | 3 |
| MOULDING WIDTH : | 015 | 4 | 5 | 6 |
| WHITE TRIANGLE | | 7 | 8 | 9 |
| SPACER | | 0 | CLR | |
| SIZE | 5 | | | |
| | | ENTER | | RETURN ? |

STEP 2

-Enter the moulding's width (w/out rebate) in mm, confirm with ϵ

-Pressing the key of top presser types proposed by the machine, leave it on the top presser you want for this moulding. Pushing on key SPACER (you will darken this key), you confirm that you want to use spacer bars with this profile. By pushing again, you cancel. Pressing the wedge SIZE key several times, leave it on the size & type you want (Hardwood "HW" or normal –no mark after size). Press β to access to the second screen of joining parameters.

| | | | | | | |
|----------|-----|-------|--------|------------|--------------|---|
| POSITION | 1 | 2 | 3 | 1 | 2 | 3 |
| NUMBER | 008 | 000 | 000 | 4 | 5 | 6 |
| | 1 | 0 | 0 | 7 | 8 | 9 |
| POSITION | 4 | 5 | 6 | 0 | CLR | |
| NUMBER | 000 | 000 | 000 | | | |
| | 0 | 0 | 0 | | | |
| | | ENTER | RETURN | \uparrow | \downarrow | |

STEP 3 -Enter now the stapling positions (distances in mm from the back of moulding) and the number of

wedges for each position. Confirm with ϵ every time. To move the cursor, use the keys γ and β .

TIP : If you want more than one stapling position, it would be wise to memorise the stapling positions from the smallest value (closest to the back) to the biggest value (closest to the rebate of moulding); the machine's programme executing the assembly process exactly in the order memorised (from 1st to 6th position), this would make it work faster and create for the operator a bigger space to bring the corner out of machine. When all information has been given, press ENTER to memorise. The machine will propose you to go on Creating new references. RETURN key brings you back to FILE MANAGER, then to MAIN MENU. On all screens, the ? key provides you some help and short explanations.

EXECUTION OF AN ARTICLE (JOINING A FRAME)

| | |
|----------------------------|---|
| EXECUTION MENU | |
| EXECUTE FILE | |
| EXEC. DIRECTLY or LAST JOB | |
| RETURN | ? |

| | | | | | |
|----------------------|--|--|---|-----|---|
| EXECUTE FILE | | | 1 | 2 | 3 |
| | | | 4 | 5 | 6 |
| REFERENCE TO EXECUTE | | | 7 | 8 | 9 |
| 0000124 | | | 0 | CLR | |
| | | | | | |
| RETURN | | | ? | | |

On MAIN MENU, press EXECUTE. In EXECUTION MENU, there are 2 possibilities:

1) EXECUTE FILE; to assemble a frame with a moulding or profile that is in File memory; enter the article number and press ϵ to confirm. To correct a mistake in moulding number, press CLR and enter the item number again. RETURN key brings you back to previous menu.

PLEASE
USE THE BUNG BLACK TRIANGLE
WEDGES SIZE 10 HW WITHOUT
SPACER WITH THIS ARTICLE.
 Touch the screen to continue

| | | | | |
|------------|------------------|------------------|------------------|-----|
| Moulding : | 0000124 | 1 | 2 | 3 |
| Width : | 018 | 4 | 5 | 6 |
| POSITION | ¹ 005 | ² 000 | ³ 000 | 7 |
| NUMBER | 1 | 0 | 0 | 8 |
| POSITION | ⁴ 000 | ⁵ 000 | ⁶ 000 | 9 |
| NUMBER | 0 | 0 | 0 | 0 |
| | | | | CLR |
| | | | | ← |
| | EXECUTE | RETURN | ↑ | ↓ |

The CS 3099 reminds you the accessories needed –type of top presser end; with or without spacer bars; which size and type of wedges to be used - to join this moulding in the best way. Make the necessary changes on machine and load the correct cartridge. Press anywhere on screen to continue.

A new screen comes up showing the parameters that are preset for this specific moulding. Press EXECUTE, CS 3099 invites you to PLS ADJUST THE TABLE (Tc on Fig2, page A or section, page 5). As soon as you bring up the pre-clamp lever, the machine –or more precisely, its wedge distribution system- will go to the first stapling position.

| | |
|-----------------------|----------------------|
| MOULDING: 00000124 | Moulding Width : 018 |
| BUNG : BLACK TRIANGLE | Size 10HW |
| EXECUTION : MANUAL | SPACER |
| POSITION | 1 2 3 |
| NUMBER | 010 000 000 |
| | 2 0 0 |
| | 4 5 6 |
| POSITION | 000 000 000 |
| NUMBER | 0 0 0 |
| | 45° |
| | RETURN |
| | ? |

A new screen comes up proposing you the priority execution mode preset in the machine’s function parameters; EXECUTION : MANUEL or AUTOMATIC: Automatic means that the machine will make the whole assembly cycle, just by pushing on the foot pedal. Manual means that the machine will clamp mouldings with foot pedal, then the stapling

button DA (Fig1, page A) must be pushed to insert wedges. (For different manual modes, see section on page B).

The machine still allows you to change the execution mode proposed, by just pushing on the same key.

TIP: When you start with a new moulding or profile, join the first corner in MANUAL mode to adjust perfectly the backfences, assembly angle etc by clamping the mouldings and seeing the result without inserting wedges yet. Then for the following corners or frames, change to AUTOMATIC. If all these chops were cut on the same cutting machine, the machine will give you every time exactly the same result as the first corner.

In the same way, the **SPACER** key is darkened if spacer bars were needed for this moulding. You can still decide to change it by pushing simply the same key.

These changes will not affect the article in preset memory of the machine and will be valid only for this work with this moulding.

45° The machine always proposes a rectangle frame, as the key on execution screen shows that the machine is currently assembling moulding chops that are cut at 45°. If you want to make 6-sided or 8-sided frames with any profile in memory of the machine, just pressing this key to 30° for 6-sided (hexagon) or to 22.5° for 8-sided (octagon), your CS 3099 will immediately take into account the new form of the frame and calculate the new stapling positions depending on the initial information in FILE for this moulding, so that the wedges are inserted exactly to the same places of the moulding.

You need to insert the corresponding angle attachments (available as options, see **Options, page 1**) between the mouldings and the 90° assembly angle of the machine.

BOTH IN AUTOMATIC and MANUAL MODES OF EXECUTION, THE FOOT PEDAL MUST REMAIN PUSHED DURING THE WHOLE JOINING CYCLE.

For mechanical reasons, the maximum width of mouldings and the closest positions to the inside of frame are limited as follows for hexagon and octagon frames:

| | Minimum Distance of Wedge to Rebate | Maxi Width of Moulding |
|----------------|--|-------------------------------|
| OCTAGON | (8-sided)7mm (5/16") | 115mm (4½") +rebate |
| HEXAGON | (6-sided)3mm (1/8") | 120mm (4¾") +rebate |

2) EXECUTE DIRECTLY OR LAST JOB

This is the second possibility in the execution menu which calls up the last joining parameters which have been executed, created or modified. This execution mode is very interesting to be used in three cases:

- When the same work (or a series in production with the same profile) is to be continued after the machine has been stopped. In this case, the machine will not ask for the accessories needed, presuming that they are left on the machine since the last assembly job- and will go immediately to the execution screen.
- As in this case all parameters can be modified without altering them in the file memory, a moulding in memory can be assembled exceptionally in a different way. For example, when wedges #10 are needed and you are out of stock of this size, you can use size #5 and put twice as many wedges in each stapling position.
- When a moulding that is not in file is to be assembled and if you don't wish to memorise this moulding. Nevertheless, if this moulding may be assembled again, it is advised to memorise it.

PREPARATION AND RECORDING OF AN ARTICLE WITH MULTIPLE (up to 6) STAPLING POSITIONS

2 mm MINIMUM
approx: 1/8 "

WEDGE
POSITION

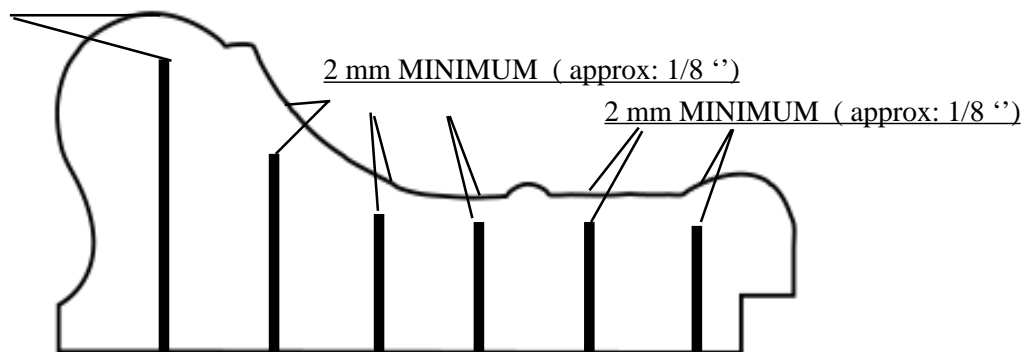

Depending on their width, mouldings can be assembled in up to 6 stapling positions. The rule of minimum 2mm (1/8") clearance above the wedges gives us the maximum penetration possibility for each position. This will determine the best wedge size for all the positions and the quantity of wedges to be used in each position.

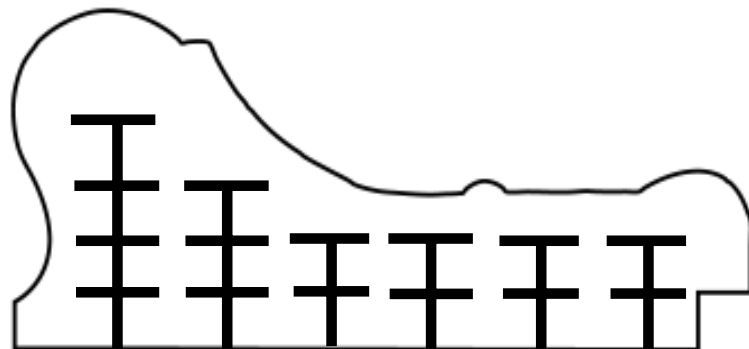

Advice: To get the best and tightest corners possible, make sure that wedges in each position penetrate and pull together at least 2/3 of the height in this area.

MEASURING THE WIDTH OF MOULDING

The rebate is not counted.

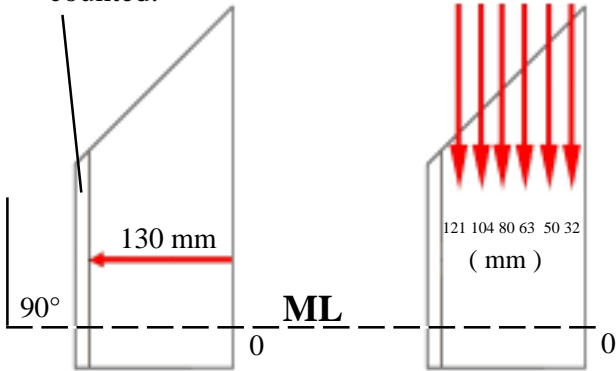

Advised Chart to fill for each item

| | | | | | | |
|------------------|-------------------------|----|----|----|-----|-----|
| ARTICLE Nr | 399 | | | | | |
| WIDTH | 130 mm | | | | | |
| POSITIONS | 32 | 50 | 63 | 80 | 104 | 121 |
| WEDGE SIZE | TYPE 10 (normal) | | | | | |
| NUMBER OF WEDGES | 4 | 3 | 2 | 2 | 2 | 2 |
| TOP PRESSER | GREEN RUBBER45(= long) | | | | | |
| SPACERS | NO | | | | | |

MEASURING THE WEDGE POSITIONS

The width of the moulding not counting the rebate and the positions of the wedges are measured in millimetres, perpendicular to and starting from the outside edge (back) of the moulding. The stapling points (=positions) are projected perpendicularly onto the 90° line of measurement of the width ML (see above). The measurement of each point starts from the outside edge.

TIP: If you have drawings of your mouldings on a catalogue, in actual sizes, it will be much easier to work on drawings and to measure with a metric rule.

Once all the measures have been taken and noted, a table like the one above can be made up for each profile or moulding, before entry on the screen of the machine.

JOINING FILES

REFERENCE TO CREATE

0000399

1 2 3

4 5 6

7 8 9

0 CLR

↩

RETURN ?

REFERENCE 0000399

MOULDING WIDTH : 130

GREEN RUBBER 45

SPACER

SIZE 10

ENTER RETURN ?

1 2 3

4 5 6

7 8 9

0 CLR

↩

↪

On MAIN MENU, press JOINING FILE, followed by CREATE. Enter the item number, confirm with ↵.

Enter now the moulding width in mm. Don't forget to confirm with ↵ each numeric information you enter. Press on the key proposing a top presser type until your choice comes up. Press and darken the SPACER key, if you want to use spacer bars. Otherwise, leave it so. Press on SIZE until the size and type of wedge you want comes up (out of 10 choices).

Press ↵ to continue.

| | | | | | | |
|----------|-----|-------|--------|---|-----|---|
| POSITION | 1 | 2 | 3 | 1 | 2 | 3 |
| NUMBER | 005 | 00 | 00 | 4 | 5 | 6 |
| POSITION | 4 | 5 | 6 | 7 | 8 | 9 |
| NUMBER | 005 | 00 | 00 | 0 | CLR | |
| | 1 | 0 | 0 | ↩ | | |
| | ← | ENTER | RETURN | ↑ | ↓ | |

Enter now the stapling positions in mm and number of wedges for each position. Confirm with ↵ every time. To move the cursor, use the keys ↵ and ↵. In case of mistake press CLR. **TIP** : Although CS 3099 accepts stapling positions in any order and would execute the assembly

process exactly in the order memorised (from pos.#1 to 6), it would be wise to memorise the stapling positions from the smallest value (closest to the back) to the biggest value (closest to the rebate of moulding); this would make it work faster and create for the operator a bigger space to bring the corner out of machine.

When all information has been given, press ENTER to memorise.

MODIFICATION OF AN ARTICLE

| | |
|----------------------|-------------|
| CS 3099 MAIN MENU | |
| EXECUTE | |
| JOINING FILE | MAINTENANCE |

| | |
|---------------|----------------------------|
| FILES MANAGER | |
| CREATE | FREE MEMORY 5968 / 6000 |
| MODIFY | ? |
| ERASE | RETURN |

On MAIN MENU, press JOINING FILE, followed by MODIFY.

| | | | |
|----------------------|--------|-----|---|
| JOINING FILES | 1 | 2 | 3 |
| | 4 | 5 | 6 |
| REFERENCE TO MODIFY | 7 | 8 | 9 |
| 0000325 | 0 | CLR | |
| | ← | | |
| ARTICLES LIST RETURN | RETURN | ? | |

Enter the item number to be modified.

The articles in file can be seen via the key ARTICLES LIST.

Confirm the number with ξ to open the file and to modify it. All parameters of a file (accessories & joining process) can be modified in the same way as when created. (See page 8 PRESET RECORDING).

To go from the first page of a file to the second, use \mathbb{P} . To return from 2nd page to the first, use \mathbb{U} .

Once all the modifications have been recorded, press ENTER key to confirm and to memorise the new data for this article.

Note: If you add stapling positions to a file, the assembly process will be executed in the order of stapling positions (from the 1st to 6th). This is to say, if you modify a file by adding a 3rd position *between* two already existing, it is normal that the machine moves from first to second position, then only returns half way back to execute the third position.

CANCELLATION OF AN ARTICLE

| | |
|----------------------|-------------|
| CS 3099 MAIN MENU | |
| EXECUTE | |
| JOINING FILE | MAINTENANCE |

| | |
|---------------|--------|
| FILES MANAGER | |
| CREATE | |
| MODIFY | |
| ERASE | ? |
| | RETURN |

On MAIN MENU, press JOINING FILE, followed by ERASE.

| | | | |
|--------------------|--------|-----|---|
| JOINING FILES | 1 | 2 | 3 |
| | 4 | 5 | 6 |
| REFERENCE TO ERASE | 7 | 8 | 9 |
| 0000055 | 0 | CLR | |
| | ← | | |
| ARTICLES LIST | RETURN | ? | |

Enter the item number to be cancelled from memory.

The articles in file can be seen via the key ARTICLES LIST. Confirm the number with ξ . Your CS 3099 will still ask you if you are sure to be willing to cancel this item from memory. Confirm your decision or Return.

SCREEN MESSAGES

Your CS 3099 includes a continuous help function that checks your instructions and which can be accessed either at your request by pressing ? key on any screen or if there is an incident or programming mistake. For example:

**The Article 0000857
is not in File.**

Do you want to create it ?

YES NO

Your CS 3099 is informing you that the item nr 857 you want to execute is not in Memory File of the machine and is proposing you to create it immediately...

**INCIDENT IN TOP PRESSER'S
COMING DOWN !**

Either too big distance between top presser and mouldings (more than 50mm=2") or top presser coming down too slowly.

ASSEMBLY PROCESS FINISHED

RELEASE THE FOOT PEDAL, DON'T PUSH THE STAPLING BUTTON ANY MORE AND REMOVE THE MOULDINGS.

Solutions to operation faults and advice messages on screen help the operator during all the steps of the CS 3099's function.

INSUFFICIENT PRESSURE ALARM !

There is not enough air pressure for the machine to work normally. Check the air arrival. Once the problem is solved, machine comes back in Main Menu.

Your CS 3099 cannot function without compressed air. This message will come up also, if the air pressure comes down below 5 bars (70 psi), as at this moment the machine does not have the power needed to insert or to stack wedges in every kind of mouldings, especially hardwoods. Therefore instead of joining badly and wasting mouldings, it will ask for higher pressure. Check if your compressor or the air arrival is OK.

WARNING !

CLAMP SAFETY ACTIVATED !

EITHER NO MOULDINGS ON THE MACHINE OR TABLE BADLY ADJUSTED.

The CS 3099 is equipped with a sensor that checks if the machine is actually clamping mouldings and prevents the machine from inserting wedges if this is not the case.

This message may appear:

- When one of the mouldings is missing on the machine**
- If the sliding table is badly adjusted or simply not locked well enough, making the machine unable to clamp well**
- If the mouldings are too soft, too powerful clamp pressure may also result in this message; decrease the clamp pressure at the adjuster next to the screen.**

MAINTENANCE

**BEFORE ANY INTERVENTION,
UNPLUG THE POWER SUPPLY AND CLOSE THE AIR VALVE.**

1) LUBRICATION

From time to time, remove the wedge distributor (Block H) and clean it (by air) without dismantling it. It is recommended that you grease the hammer (wedge driver blade) periodically. To do this, block H must be removed and a small quantity of grease is then put in the housing of the hammer at the base of block H.

If the top plunger slides (comes forward and back) with difficulty, oil the horizontal axis, using SAE 20/40 oil.

2) CLEARING OF A WEDGE STUCK IN THE DISTRIBUTOR

INCIDENT IN WEDGES INSERTION !!!

STOP THE MACHINE AND CHECK IF THERE ARE NO WEDGES JAMMED IN WEDGE DISTRIBUTION BLOCK.

During assembly, one or more wedges may get stuck in the wedge distributor (block H). The CS 3099 will then display the message opposite.

Or if you incidentally lift the top presser plunger when with a wedge cartridge is on machine, this may half engage a wedge in the distribution mechanism.

-Switch off the power and close the air valve.

-Try to remove the cartridge that is on machine. If it resists, use the wedge pusher tool (in accessory box) to replace the wedge back in cartridge.

-The wedge pusher must not penetrate more than 6mm (1/4") into the wedge distributor.

-In case of hammer and wedge jamming, see the following section (3)

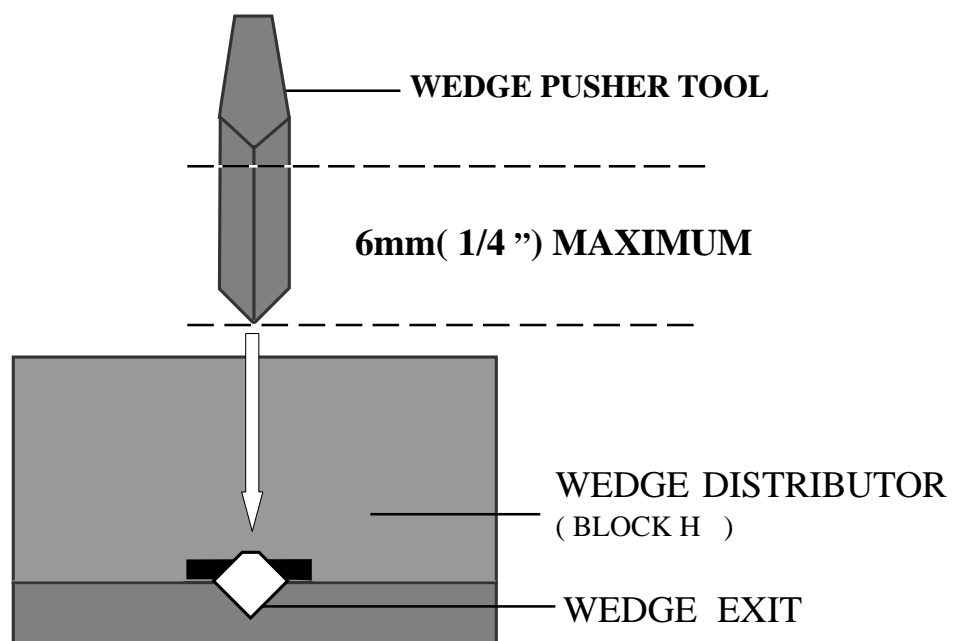

MAINTENANCE

**BEFORE ANY INTERVENTION,
UNPLUG THE POWER SUPPLY AND CLOSE THE AIR VALVE.**

3) IN CASE OF HAMMER & WEDGE JAMMING

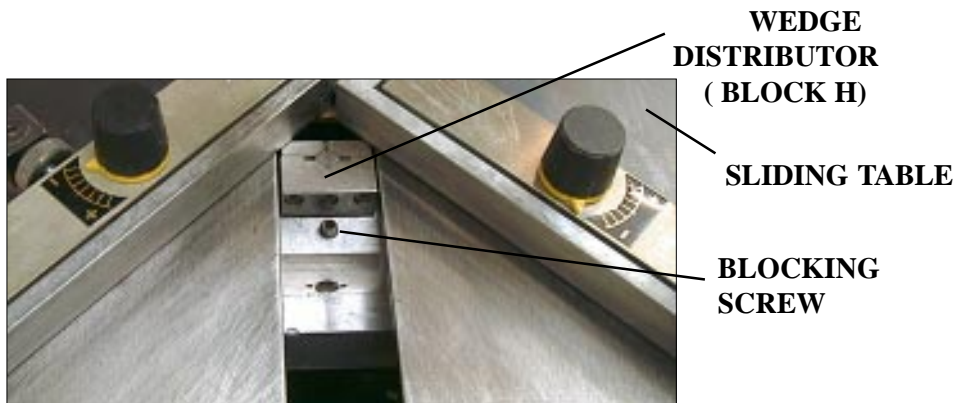

SCREW POSITIONS OF BLOCK H

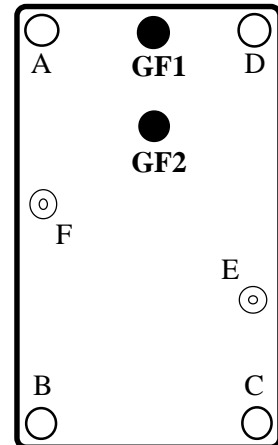

In case of the hammer (wedge driver blade) and a wedge jamming in the wedge distribution block also, the CS 3099 will display the message INCIDENT IN WEDGES INSERTION. In this case, proceed as follows, after having unplugged the machine from mains supply and closed the air valve.

-Remove the wedge cartridge from machine.

-With the 3mm allen key (supplied with machine), loosen (no need to remove) the blocking screw of block H (see above).

-Now lift manually the top presser plunger; this will bring up the block H out of machine.

Remove the block H from machine and check:

1) If there is no wedge or hammer stuck inside it, put it back in machine.

2) **If the hammer (like a very long wedge, approx. 8cm (3'') long) is stuck in it**, we need to open the block H to get rid of the old hammer: Use for this the smaller (2.5mm) Allen key (supplied with machine) and remove the 2 central screws (see above GF1 & GF2) that hold the fixed (square) guide of Block H in place. Remove the fixed guide completely to free the old hammer. If still not possible to get rid of the old hammer, remove the 4 corner screws (A-B-C-D) and open the block H. Two factory set locator pins E & F allow the plates to be re-positioned precisely again.

Remove the old hammer. Assemble the block H back again.

PUTTING A NEW HAMMER

- Put a drop of grease (tube of grease supplied with the machine) in the bottom hole of the wedge distributor (block H).
- Insert a new hammer into the wedge distributor from the top, with the hole of the hammer downwards.
- Re-position the wedge distributor in its housing on the machine, with the window towards the cartridge.
- If the upper end of the new hammer stays out of block H, push it fully in with a piece of wood or moulding.**
- Now, turn on power and air supply to the machine. The introduction screen comes up.
- On the MAIN MENU screen, press MAINTENANCE.
- Then press \rightarrow (next) on the next two screens. You should have reached the following screen:

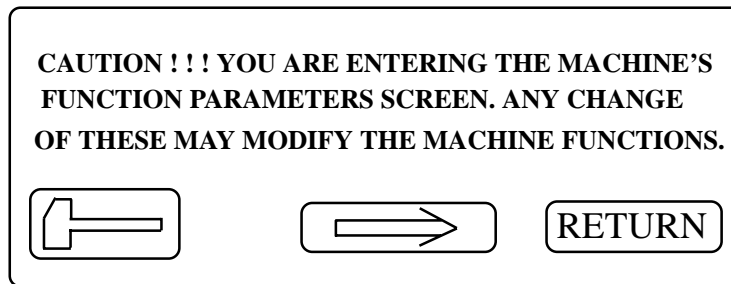

- Press on key which symbolises a hammer.
- The machine is ready for hammer change and the following screen comes up:

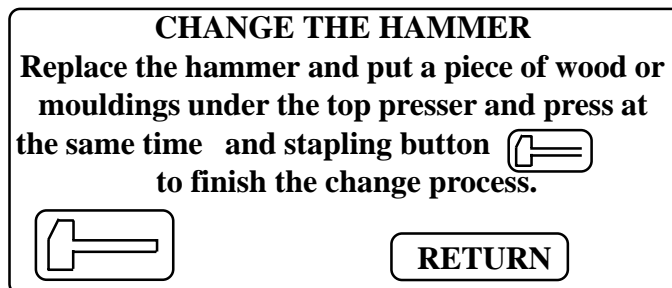

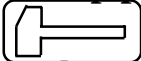
- Put any of the top presser ends (triangle or round rubber) on the machine and place a big piece of wood (hardwood is better) on the block H, under the top presser. (The distance between the top presser and the moulding should not exceed 50mm (2").)
 - Now, keeping  -key pressed on the machine, push the stapling (black) button at the same time; the machine will simulate a wedge insertion so that the new hammer can take automatically its position in the mechanism.
 - Press on RETURN on the screen.
 - Now turn off the machine from the power and air supply.
 - Tighten the blocking screw of block H (see picture page 16), using the 3mm Allen key (supplied with machine). No need to tighten too much.
- Now the machine is ready to work again.

AFTER ANY INCIDENT IN WEDGES INSERTION, IF THE HAMMER REMAINS IN BLOCK H, YOU MUST CHANGE IT.